

Large scale SiPM testing for the Cosmic Muon Veto detector

Mamta Jangra,^{a,b,*} Raj Bhupen,^{a,b} Gobinda Majumder,^b Kiran Gothe,^b Mandar N Saraf,^b Nandkishor Parmar,^b B. Satyanarayana,^b R.R. Shinde,^b Shobha K. Rao,^b Suresh S Upadhyay,^b Vivek M Datar,^c Douglas A. Glenzinski,^d Alan Bross,^d Anna Pla-Dalmau,^d Vishnu V. Zutshi,^e Robert Craig Group^f and E Craig Dukes^f

^aHomi Bhabha National Institute, Mumbai

^bTata Institute of Fundamental Research, Mumbai

^cThe Institute of Mathematical Sciences, Chennai-600113, India

^dFermi National Accelerator Laboratory, IL 60510, United States

^eNorthern Illinois University, IL 60510, United States

^fVirginia University, VA, United States

E-mail: mamta.jangra@tifr.res.in

A Cosmic Muon Veto (CMV) detector using extruded plastic scintillators is being built around the mini-Iron Calorimeter (mini-ICAL) detector at the transit campus of the India based Neutrino Observatory, Madurai. The extruded plastic scintillators will be embedded with wavelength shifting (WLS) fibres to absorb scintillating photons and propagate the re-emitted photons to the silicon-photomultipliers for the electronic signals. The CMV detector will require 760 extruded plastic scintillators to shield the mini-ICAL detector, and will require 3040 SiPMs for the readout. The design goal for the cosmic muon veto efficiency of the CMV is >99.99% and fake veto rate less than 10^{-5} . Hence, every SiPM used in the detector needs to be characterised to satisfy the design goal of the CMV. For this, a large-scale testing system was developed, using an LED driver, to measure the gain and noise rate of each SiPM, and thus determine its breakdown voltage (V_{br}) and optimum operating overvoltage (V_{ov}).

*41st International Conference on High Energy physics - ICHEP2022
6-13 July, 2022
Bologna, Italy*

*Speaker

1. Introduction

The flux of the cosmic ray muons on the earth’s surface constitutes a huge background for the experiments searching for the rare neutrino interactions. The cosmic muon flux reduces by a factor of 10^6 against a depth of ~ 1 km and 10^2 against shallow depth of ~ 100 m. An active cosmic muon veto (CMV) detector with veto efficiency $>99.99\%$ will be required for a rejection factor of 10^6 at depth of 100 m. The prototype of Iron CALorimeter (ICAL) i.e. mini-ICAL, consists of 11 layers of 5.6 cm thick soft iron plates and 10 layers of $2\text{ m} \times 2\text{ m}$ glass Resistive Plate Chambers (RPCs), an 85-ton magnet and is operational at Madurai, India. A CMV detector is being built on top of mini-ICAL (as shown in Fig. 1) with extruded plastic scintillators with embedded WLS fibres to propagate light and SiPM to detect scintillation photons. The SiPM model S13360-2050VE from Hamamatsu is used for CMVD experiment. This particular model of SiPM has a total photosensitive area of $2\text{ mm} \times 2\text{ mm}$, 1584 microcells, microcell pitch of $50\ \mu\text{m}$, fill factor of 74%, V_{br} of $(53 \pm 5)\text{ V}$ at room temperature. The SiPMs are available on panels, with each panel containing 16 SiPMs, as shown in Fig. 2.

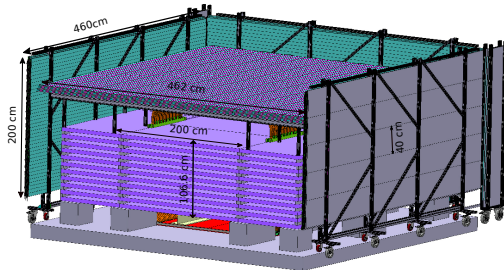

Figure 1: A schematic of the Cosmic Muon Veto Detector around mini-ICAL

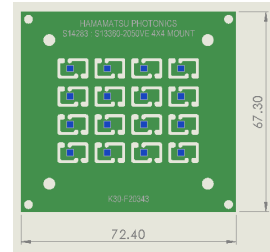

Figure 2: SiPM panel

2. Experimental setup for LED testing

The testing is performed inside a lightproof black box. The SiPM panel is mounted on one of the faces of the black box as shown in the Fig. 3. An ultrafast LED driver (CAEN SP5601) is used to expose light on the SiPM panel. A piece of tyvek paper is used to diffuse the light uniformly on all the SiPMs.

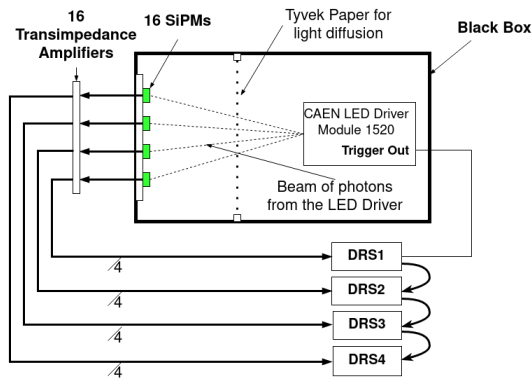

Figure 3: The SiPM mass testing experimental setup

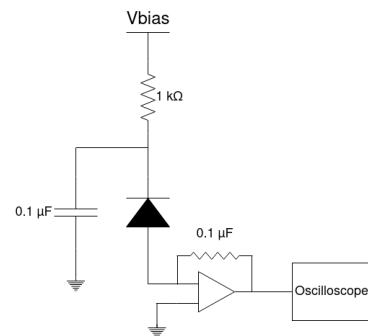

Figure 4: SiPM circuit diagram

DRS boards are connected to a computer system to collect the data [2]. A schematic of the electronic circuit for signal readout is shown in Fig. 4. A total of 218 SiPM panels were tested using this setup.

3. Calibration using LED and test results

An example of LED signal from the experimental setup can be seen in Fig. 5a. A total of 5000 events are collected for each of the SiPM. The signal is integrated within a 100 ns window for the charge collection and the pedestal is subtracted to correct for the baseline fluctuations. The charge distribution is shown in Fig. 5b for one of the SiPMs at bias voltage (V_{bias}) = 54 V.

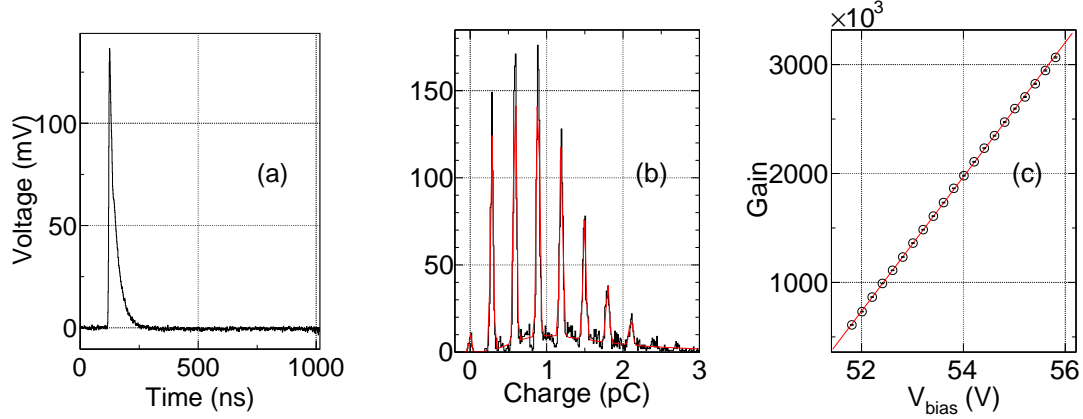

Figure 5: (a) Raw SiPM signal, (b) Charge distribution at $V_{bias} = 54$ V and (c) Calibration plot for measuring V_{br} and dG/dV for one of the SiPMs.

The total collected charge is fitted with a function [1]:

$$f(y) = Landau(y) + \sum_{a=0}^{N-1} R_a \times e^{-\frac{(y - a\mu)^2}{2\sigma^2}}$$

where N is the number of photoelectron (pe) peaks, R_a is the peak height and σ is the gaussian width of pe peak. The average gap between the consecutive peaks (μ) is measured from the fit and the gain is calculated. The data is collected for five different values of V_{bias} . The gain versus V_{bias} is plotted and fitted with a linear function as shown in Fig. 5c. From the linear fit, the slope will determine the variation in the gain with respect to bias voltage (dG/dV) and the ratio of the intercept to the slope will determine V_{br} and both the parameters are estimated for each of these SiPMs as shown in Fig. 6.

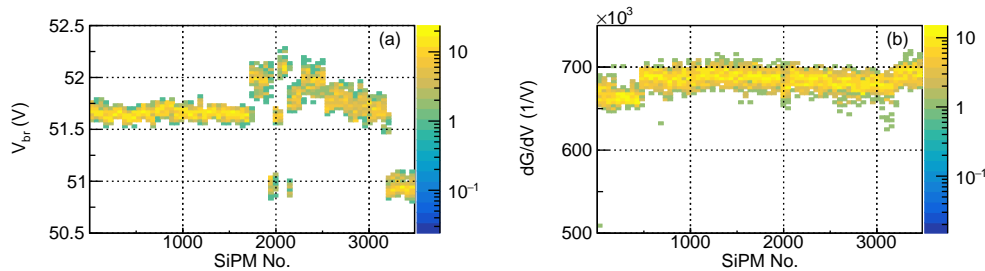

Figure 6: (a) The variation in the gain with respect to bias voltage (dG/dV) versus SiPM number and (b) V_{br} versus SiPM number at room temperature (25°C).

Noise rate measurement for SiPMs

The same light proof box is used without any LED signal. The charge is measured by integrating the signal within a 100 ns randomly chosen window with pedestal subtraction and the corresponding

charge distribution is shown in Fig. 7a for different V_{ov} . The noise rate is measured by calculating the fraction of events crossing the charge threshold (q_{th}) and the measurements are shown in Fig. 7a at different q_{th} and at different V_{ov} .

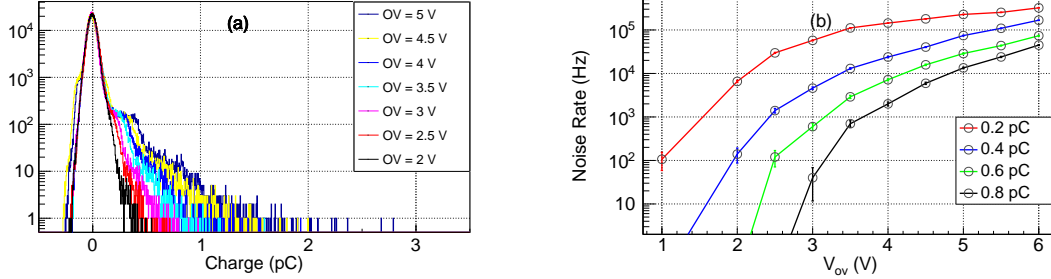

Figure 7: (a) The integrated charge distribution from the noise data at different V_{ov} and (b) Variation in the noise rate at different q_{th} for different V_{ov}

Fig. 8a shows noise rate measurements of all the SiPMs at $V_{ov}=3$ V and $q_{th} = 0.16$ pC (~ 0.5 pe at $V_{ov}=3$ V). Fig. 8b and Fig. 8c shows the correlation of the noise rate versus dG/dV and V_{br} respectively, but it is clear that there is no correlation of noise rate with dG/dV and V_{br} .

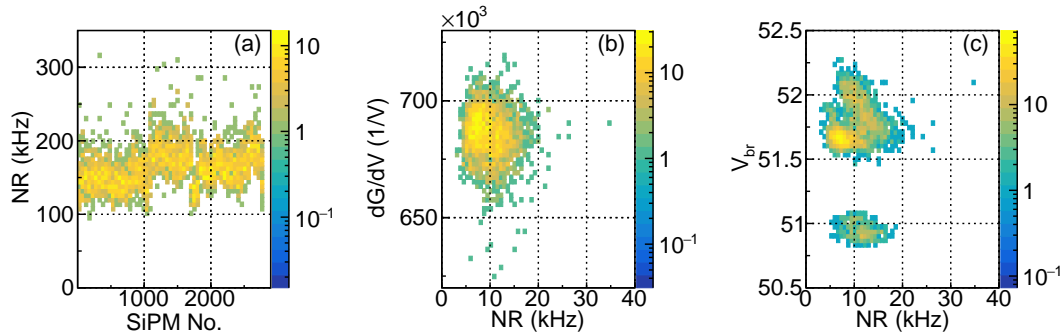

Figure 8: (a) The noise rate for all the SiPMs at 0.5 pe threshold for $V_{ov}=3$ V, (b) Correlation plot of noise rate (at 1.5 pe threshold) versus dG/dV and (c) Correlation plot of noise rate (at 1.5 pe) versus dG/dV

Conclusion

Out of total 3488 SiPMs, all SiPMs are suitable for CMVD purposes except one with low gain i.e. $dG/dV \sim 5.1 \times 10^5$ as compared to the average gain of all other SiPMs i.e. $dG/dV \sim 6.8 \times 10^6$. The variation in the V_{br} values for different SiPMs is from 50.8 V to 52.5 V. The maximum noise rate at 0.5 pe threshold is 316.8 kHz which is within the tolerable range.

Acknowledgements

We would like to sincerely thank the expert committee of "Infosys-TIFR Leading Edge Travel Grant" for funding the travel. We would also like to thank HBNI and all the members of INO lab.

References

- [1] Mamta Jangra, et al., *Characterization of Silicon-Photomultipliers for a Cosmic Muon Veto detector*. *Journal of Instrumentation*, 10.1088/1748-0221/16/11/P11029 **16** (2021) P11029.
- [2] DRS4, *DRS4 Evaluation Board User's Manual*, <https://www.psi.ch/sites/default/files/2020-02>.