

# Characterization of the photomultiplier tube for the LHAASO electromagnetic particle detector

---

**Yanhong Yu**<sup>\*†</sup>

*Institute of Frontier and Interdisciplinary Science, Shandong University, Qingdao, 266237, China*

*E-mail: [yuyh@mail.sdu.edu.cn](mailto:yuyh@mail.sdu.edu.cn)*

**Hongkui Lv**

*Key Laboratory of Particle Astrophysics, Institute of High Energy Physics, Chinese Academy of Sciences, Beijing, 100049, China*

**Dong Liu**

*Institute of Frontier and Interdisciplinary Science, Shandong University, Qingdao, 266237, China*

**Xiangdong Sheng**

*Key Laboratory of Particle Astrophysics, Institute of High Energy Physics, Chinese Academy of Sciences, Beijing, 100049, China*

**Cunfeng Feng**

*Institute of Frontier and Interdisciplinary Science, Shandong University, Qingdao, 266237, China*

## On behalf of the LHAASO Collaboration

Over 5000 XP3960 type photomultiplier tubes (PMTs) are being deployed for electromagnetic particle detectors (EDs) of LHAASO (Large High Altitude Air Shower Observatory) project. To meet the large dynamic range requirement (4 orders of magnitude), an optimal design of the voltage divider with anode and the 6<sup>th</sup> dynode readout for this type of PMT is designed. Using this divider, the characteristics of the output waveforms and cross-talk effect between the two outputs are studied. Hundreds PMTs have been tested at the PMT test bench. The statistical results such as the single photoelectron (SPE) response relative transit time and pulse linearity are presented in this paper.

*36th International Cosmic Ray Conference -ICRC2019-  
July 24th - August 1st, 2019  
Madison, WI, U.S.A.*

---

<sup>\*</sup>Speaker.

<sup>†</sup>This work is supported in China by NSFC 11775131.

**Table 1:** Summary of the requirements of PMT for LHAASO-ED

Measurement item	Requirement
High Voltage	1200±100 V
TTS	<4.5 ns
Dark noise rate	<200 Hz
$I_a$ (peak linear current of anode)	>23.3 mA
$I_{ea}$ (peak liner current of equivalent anode)	>990 mA
Anode/Dynode ratio	90-150
Temperature Coefficient	0.2 %/°C

## 1. Introduction

The Large High Altitude Air Shower Observatory (LHAASO) is a new generation experiment, which will observe the high energy cosmic ray sources at a large spectral window from sub-10 TeV to 100 PeV [1]. The one square kilometer array (KM2A) in LHAASO consists of 5195 electromagnetic particle detectors (EDs) and 1171 muon detectors (MDs) for measuring the number density and the arrival time of extensive air shower (EAS) secondary particles. Each ED unit consists of 4 plastic scintillation tiles of 0.25 m×1 m×0.01 m each. To collect the scintillation photons, a photomultiplier tube (PMT) is coupled to the end of 96 wavelength-shifting (WLS) fibers embedded in the grooves of scintillation tiles.

The quality of PMTs will directly affect the performance of the EDs. The requirements for LHAASO experiments are summarized in Table 1. Transit time spread (TTS) is the transit time fluctuation of each photoelectron when the photocathode is fully illuminated with single photons. The TTS of PMT should be less than 4.5 ns to ensure that the time resolution of the ED is less than 2 ns. To reduce the contribution of PMT to the noise signal the dark noise rate of the PMT is required to be less than 200 Hz. The EDs will work at the wild, and the ambient temperature fluctuates more than a few tens degrees from day to night and winter to summer. The absolute temperature coefficient of PMTs should be less than 0.2%/°C to ensure that the annual variation of the single-particle amplitude of EDs less than ±5%.

To cover the large cosmic ray energy range from 10 TeV to 100 PeV, the peak linear current of PMT must be more than 990 mA at a comparatively low gain of  $3.4 \times 10^5$ . According to the primary study on the Hamamatsu R11102 PMT [3], a new divider circuit with two outputs (anode and 6<sup>th</sup> dynode) for XP3960 PMT is designed to meet the 4 orders of dynamic range requirement. The design of XP3960 voltage divider and some characteristics are described in section 2. Using the new divider, some PMT performance such as gain, charge non-linearity are measured using the test system described in section 3. All the test results are summarized in section 4 and 5.

## 2. Design of voltage divider

### 2.1 HZC XP3960 PMT

The XP3960 PMT(Figure 1) manufactured by HZC photonics is a 1.5-inch diameter photo-cathode with 9 linear-focused dynode stages. Its inner spherical cathode window and fewer dynode

stages structure allow for good time response and pulse linearity. According to the datasheet, the TTS can achieve 0.6 ns (at a high voltage of 2000 V) and a linearity of anode current up to 30 mA (at a high voltage of 1300 V), the typical quantum efficiency dependence on wavelength with a maximum of about 25% around 420 nm and 19% around 490 nm. The relative temperature coefficient of anode sensitivity lower than 0.15%.



(a) XP3960

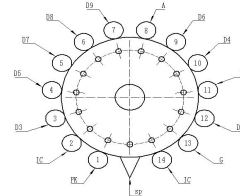

(b) The map of dynode pins

**Figure 1:** The picture of XP3960.

## 2.2 High voltage divider design

The anode linearity current in the pulse mode is mainly limited by the space charge effects between the last several dynode stages. With a low gain and comparatively low electron density at the operating voltage, the dynode is suitable to detect the optical signal with a large number of photoelectrons.

The XP3960 PMT is developed as “two outputs” device (anode and the 6<sup>th</sup> dynode) to meet the large dynamic range requirements. As shown in Figure 2, the interstage voltage for the dynodes are supplied by a series of voltage-dividing resistors (from R1 to R11). As a corrective action to overcome space charge effects, the voltage applied to the 6<sup>th</sup> stages is set at a higher value than the standard voltage distribution.

Several parallel connected decoupling capacitors (C1 to C5) in the last few stages can supplement the PMT electric charge and suppress the voltage drop between the last dynode stage and anode, resulting in a significant improvement in pulse linearity. Damping resistors (R13 to R17) are connected to the last dynode stages to reduce ringing in the output waveform [4].

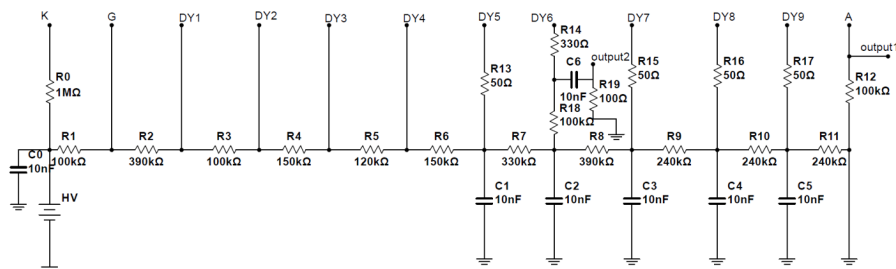
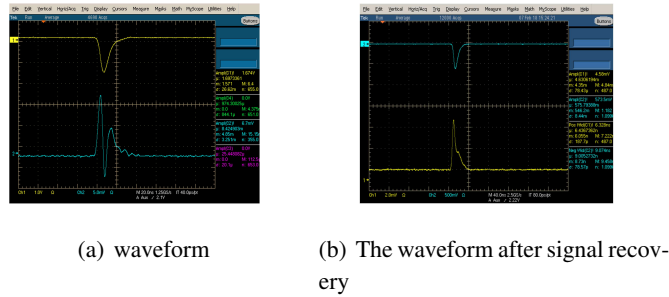

**Figure 2:** Schematic of the XP3960 PMT voltage divider.

### 2.3 Cross-talk effect between DY6 and anode

The signal waveform quality and integral charge are important factors for the linearity measurement and event reconstruction of EDs, therefore the quality of the signal extracted from DY6 is studied. Circuit simulation and the experiment results show that the waveform distortion caused by the circuit design can be ignored. However, it is found that cross-talk effect between anode and 6<sup>th</sup> dynode for XP3960, make the dynode signal distorting.

The typical signals of anode and 6<sup>th</sup> dynode obtain from the digital oscilloscope, as shown in Figure 3(a), the undershoot at tail of the 6<sup>th</sup> dynode waveform is evident. Its appearance coincided with the peak of anode pulse current at the same timescale, and it disappeared when the 9<sup>th</sup> dynode and anode has no interstage voltage (namely anode has almost no signal). The stem pins of 6<sup>th</sup> dynode and anode are adjacent (Figure 1(b)), the undershoot is caused by anode pulse coupling in the 6<sup>th</sup> dynode through the parasitic capacitance between the dynode and anode leads, and its amplitude of distortion increased with gain ratio between these two outputs. The cross-talk effect



**Figure 3:** (a)The signal of dynode(blue) and anode(yellow); (b)The waveform of the 6<sup>th</sup> dynode (yellow) and anode(blue) after signal recovery.

is restrained by removing the metal cylinder in PMT socket which may cause the parasitic capacitance. Furthermore, the damping resistance of 6<sup>th</sup> dynode R14 increase to 330  $\Omega$  from 50  $\Omega$  to reduce cross-talk current and suppress signal oscillation. A waveform of the 6<sup>th</sup> dynode after signal recovery is shown in Figure 3(b).

## 3. The PMT test system

### 3.1 PMT test bench

As shown in Figure 4(a), a multi-functional PMT test bench has been developed for studying the performances of the 1.5-inch PMT [2]. The test bench consists of light tight box, pulsed light sources, high-voltage supply module, electronics and data acquisition system. The light from a LED driven by a pulse generator (BNC577) or picosecond light pulse laser (Hamamatsu PLP-10), is guided into 8 PMTs in the box through 8 optical fibers. A 16-channel charge-to-digital converter (QDC) module (CAEN V965) is used to measure the charge of the PMT output signals. A scaler module (CAEN V560E) is used to test the dark noise rate by counting the standard NIM signal transformed from the PMT signal by a low threshold discriminator (LTD, CAEN N845). A time-to-digital converter (TDC) module (CAEN V775N) is applied to measure the time characteristic of PMT. All the equipment is controlled by a central workstation.

**Table 2:** Summary of the test accuracy of the PMT test system

Measurement item	Accuracy
High Voltage	$< \pm 0.4\%$
TTS	$< \pm 0.1$ ns
$I_a$ (peak linear current of anode)	$< 0.4$ mA
$I_{ea}$ (peak linear current of equivalent anode)	$< 11.5$ mA
Temperature Coefficient	Charge $< \pm 0.4\%$ Temperature $< \pm 0.4$ °C
Transit time	$< \pm 0.1$ ns

### 3.2 The experimental setup of charge non-linearity

The schematic of experimental setup used to study the non-linearity of PMT is shown in Figure 4(b). The PMTs are illuminated by a movable LED device. The LED is pulsed by a series of short pluses from a function generator (Tektronix AFG3252C). The PMT outputs of both anode and dynode are acquired by a digitizing oscilloscope (Tektronix MDO3054) and recorded by computer with a LabView program.

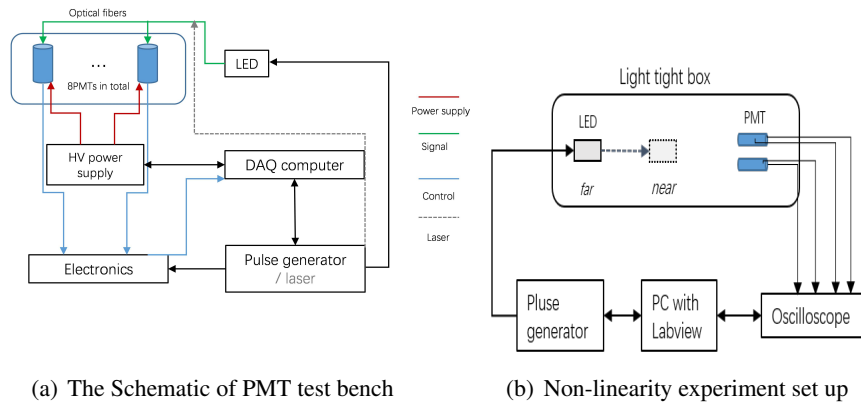

**Figure 4:** (a) The Schematic of PMT test bench; (b) The experimental setup of charge non-linearity.

## 4. Measurements

The test accuracy of the PMT test system is summarized in Table 2. In this sections, it will present the detailed test methods and performances of working high voltage (HV), anode and dynode linearity, the ratio of anode to dynode.

### 4.1 Working voltage setting

The average number photoelectrons of ED is 20 for one particle. The corresponding operated voltage that determined by measuring single photoelectron(SPE) spectrum and the relationship between the gain and supplied voltage does not take into account the difference in sensitivity of cathode (SK) and quantum efficiency (QE)[2]. Therefore, we developed a multi-photon method

to calibrate the working voltage. An initial high voltage is given by measuring single photoelectron(SPE) spectrum and the relationship between the gain and supplied voltage, and then adjust the high voltage to make sure that the output signals of PMTs are the same at the same light intensity. Figure 5 shows that there is a proportional relationship between the SK and the high voltage difference measured by two methods.

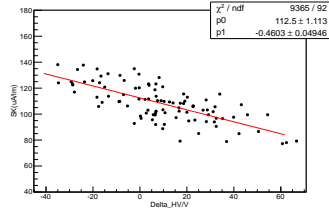

**Figure 5:** The relationship between the difference between the two methods and SK.

#### 4.2 The linearity of dynode and anode

The “bi-distance method” is used to quantify the linearity of the PMT [2]. A LED for this measurement is pulsed by a series of rectangular pulses with a width of 30 ns and pulse frequency of 1 KHz. To produce a linear increasing of light intensity, the LED can be moved to adjust the distance between the fiber and PMT window. The non-linearity (NL) can be described by the following formula,

$$NL = \left( \frac{Q_{far}}{Q_{near}} - \lambda \right) / \lambda \quad (4.1)$$

where  $Q_{near}$  ( $Q_{far}$ ) is the charge of the signal while the LED located at the near (far) position and  $\lambda$  is light intensity ratio of far to near. Change the light intensity by changing the amplitude of the pulse generator to obtain the nonlinearity of the different light intensities. A non-linearity above  $\pm 5\%$  is considered beyond the linearity of the PMT. In Figure 6(a), the results of the linearity measurement for the dynode ( $Idy_6$ ) and anode ( $Ia$ ) are shown. Using this divider, the peak linear current of anode could be more than 50 mA and the peak linear current of dynode achieved 10 mA.

#### 4.3 The gain ratio of anode to DY6

In order to convert the dynode current value ( $Idy_6$ ) to the equivalent anode value ( $Iea$ ), the gain ratio (*ratio*) between the anode and DY6 outputs is necessary to be determined from measurements.  $Iea$  can be described,  $Iea = Idy_6 \times ratio$ . The signal charge of the anode versus that of the DY6 is plotted in the Figure 6(b), and the slope of the resulting curve fitted by linear fitting is the ratio of anode to DY6 gain. The fitting range must be where the anode and dynode in the linear output.

#### 4.4 The relationship between working high voltage and linearity

To study the relationship between working high voltage and linearity, the power supply was varied from 1110 V to 1210 V. The experimental result (Figure 7(a)) shows that there is a proportional relationship between high voltage and ratio. The Figure 7(b) shows that for every 10 V increase in operating high voltage, the peak linear current of this PMT can be increased by 30

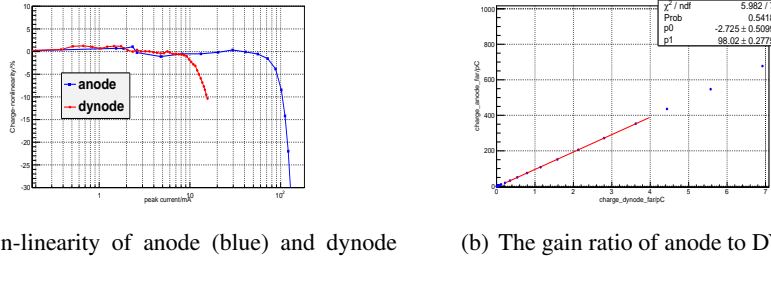
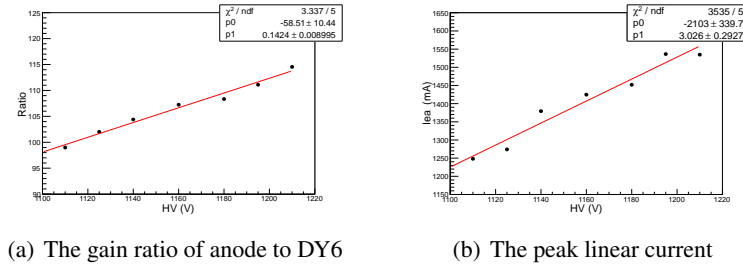

**Figure 6:** (a) Non-linearity of anode (blue) and dynode (red); (b) Correlation (in charge) between the anode and 6<sup>th</sup> dynode signals. The anode/DY6 gain ratio is about 98.0.

mA. The peak linear current corresponding to the number of particles can be determined by the following formula,

$$N_{particle} = \frac{I_{max} \times t}{Q_{sp}} \propto \frac{I_{max}}{Gain} \quad (4.2)$$

where  $I_{max}$  is the peak linear current,  $Q_{sp}$  is the charge of single particle. The number of particles detected by PMT can be increased by reducing the working high voltage.



**Figure 7:** The effect of working high voltage on linearity. (a) shows the relationship between the high voltage and the gain ratio of anode to DY6. (b) shows the relationship between the high voltage and the peak linear current.

### 5. The statistical results

Results of 500 PMTs shown in Figure 8 indicate most of XP3960 with a high dynamic range base can meet the demand. The mean of HV is 1183 V, and a few of PMT were abandoned because its working high voltage does not meet the demand of  $1200 \pm 100$  V. The mean of dark noise is 3 Hz, there are only 2 PMTs that dark noise count are more 50 Hz; There is almost no PMT whose absolute temperature coefficient more than  $0.2\%/^{\circ}\text{C}$ .

The Figure 9 is the statistical results of linearity. The average of the peak linear current of anode is 89.1 mA. The the peak linear current of equivalent anode is around 1150 mA with the ratio between anode to dynode around 109. The PMTs that did not meet demand of linearity account for about 10% of total PMTs.

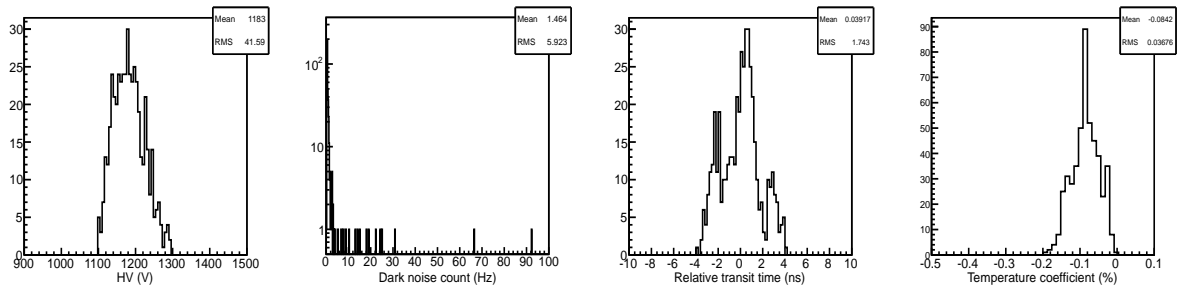

Figure 8: The statist results of HV,Beta,dark noise rate count and relative TT.

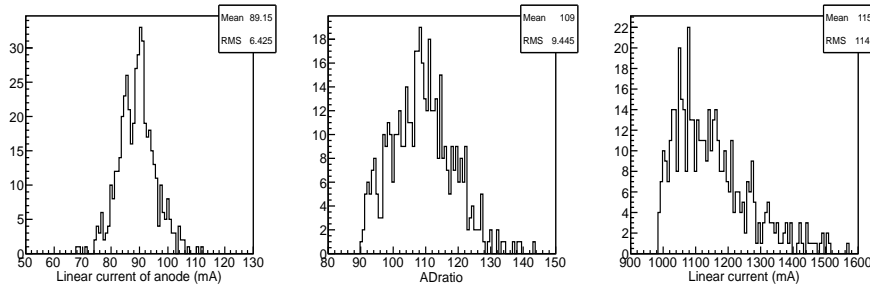

Figure 9: The statist results of linearity.

## 6. Conclusions

In the present work an optimal design of the voltage divider with anode and the 6<sup>th</sup> dynode readout for this type of PMT is designed and the quality of the signal extracted from the 6<sup>th</sup> dynode is studied. The multi-channel PMT test bench can be used to test 8 PMTs together in a single run. It guarantees that all 5195 PMTs for EDs can be tested effectively. All the results are reliable because programmable hardware is used that makes all of results are independent of manual operation. The relationship between working high voltage and linearity has been studied. The performances of this type PMT have been tested with this divider. The results show that most of PMTs that with a high dynamic range base can meet the LHAASO-ED demand.

## References

- [1] Cao Z, LHAASO collaboration. Status of LHAASO updates from ARGO-YBJ[J]. Nuclear Instruments and Methods in Physics Research Section A: Accelerators, Spectrometers, Detectors and Associated Equipment, 2014, 742: 95-98.
- [2] Wang X, Zhang Z Q, Tian Y, et al. Setup of a photomultiplier tube test bench for LHAASO-KM2A[J]. Chinese Physics C, 2016, 40(8): 086003.
- [3] Lv H, Sheng X, He H, et al. Extension of photomultiplier tube dynamic range for the LHAASO-KM2A electromagnetic particle detectors[J]. Nuclear Instruments and Methods in Physics Research Section A: Accelerators, Spectrometers, Detectors and Associated Equipment, 2015, 781: 34-38.
- [4] Hamamatsu Photonics K K. Photomultiplier tubes: Basics and applications[J]. Edition 3a, 2007, 310.