

## The Propeller White Dwarf Pulsar in AE Aquarii: A Multi-Frequency Emission Laboratory

---

**P.J. Meintjes\***

*Department of Physics, University of the Free State, PO Box 339, Bloemfontein, South Africa*

*E-mail: [MeintjPJ@ufs.ac.za](mailto:MeintjPJ@ufs.ac.za)*

The enigmatic nova-like variable system AE Aquarii shows highly-transient multi-frequency emission from radio to possibly Very High Energy (VHE) [ $\epsilon_\gamma \geq 0.1 \text{ TeV}$ ] gamma-rays that is most probably driven by the propeller ejection of material from the system by a rapidly rotating highly magnetized white dwarf. The propeller ejection of matter from the system results in the white dwarf to spin down at a rate of  $\dot{P} \approx 6 \times 10^{-14} \text{ s s}^{-1}$ , resulting in a spin-down power of  $P_{\text{s-d}} \approx 10^{34} \text{ erg s}^{-1}$ . The very effective magnetospheric propeller mechanism in AE Aquarii results in the accretion luminosity, derived from UV and X-ray measurements, to be only a fraction of the spin-down power, i.e.  $L_{\text{acc}} \sim 0.001 P_{\text{s-d}}$ . This implies that the reservoir driving the multi-frequency emission from radio to possibly VHE gamma-rays is most probably the spin-down power associated with the loss of rotational kinetic energy of the white dwarf. This places AE Aquarii in the category of the rotational driven X-ray pulsars. It will be shown that the unique multi-frequency emission from AE Aquarii is intimately tied to the the rapidly rotating magnetosphere of the white dwarf and propeller ejection of matter from the system. In this paper the energetics for particle acceleration will be investigated as well as the associated processes that drive emission from radio to possibly VHE gamma-rays in this unique system.

*Golden Age of Cataclysmic Variables and Related Objects Workshop III  
7-12 September 2015  
Palermo, Italy*

---

\*Speaker.

## 1. Introduction

Since its detection on photographic plates [1] AE Aquarii is probably one of the best studied sources in the sky. It shows multi-frequency transient emission from radio waves to possibly Very High Energy (VHE) [ $E_\gamma \geq 10^{11}$  eV] gamma-rays (e.g. [2] for a review). The emission over all frequency regimes is highly transient (e.g. [3]). The system consists of a rapidly rotating white dwarf with a rotation period of  $P_* = 33.08$  s orbiting a K3-5 secondary star every  $P_{\text{orb}} = 9.88$  hours, making this white dwarf system one of the most asynchronous rotators among the cataclysmic variables [4]. It has been noted that the pulsed fraction of the 33 s oscillation in optical (see Fig. 1) is anomalously low for an accreting system [5] resulting also in a low X-ray to optical luminosity ratio in AE Aquarii (e.g. [6]), similar to other DQ Hercules, hence its initial classification as a DQ Her type system.

### 1.1 The Magnetic Propeller in AE Aquarii

The nearly continuous and rapid flaring [5] that is so prominent in AE Aquarii has been explained in terms of the propeller ejection of material from the system and the associated radiative cooling of colliding blobs in the propeller ejecta [7]. The magnetic propeller mechanism in AE Aquarii is the direct result of the rotational velocity of the white dwarf's magnetosphere exceeding the Keplerian velocity of the mass-flow stream from the secondary star by a significant amount [8], which is illustrated in Fig 2. The exact mechanism driving the propulsion of matter from the system (see Fig. 3) has been explained in terms of two different models, i.e. a magnetic propulsion of diamagnetic blobs as they interact with the fast rotating magnetosphere [9, 10, 11], and alternatively, mixing of magnetospheric field through Kelvin-Helmholtz instabilities resulting in magnetized blobs being ejected from the system [12, 13]. The propeller ejection of matter results in the white dwarf to spin down at a rate of  $\dot{P} \approx 5.6 \times 10^{-14}$  s s<sup>-1</sup> [14], with an associated loss of rotational kinetic energy of the order of  $P_{\text{s-d}} = I\Omega\dot{\Omega} \approx 10^{34}$  erg s<sup>-1</sup> (e.g. [11]).

Non-thermal radio outbursts have been detected from the AE Aquarii [15] and quantified in terms of expanding synchrotron emitting clouds of relativistic electrons [16]. This was the first direct evidence that AE Aquarii contains a particle accelerator that can accelerate electrons to relativistic energies. The transient nature of the non-thermal radio outbursts placed AE Aquarii in a category similar to Cyg X-3 [16], albeit at a lower level. The detection of transient non-thermal radio flares from AE Aquarii was instrumental in the initiation of a search for TeV gamma-ray emission from AE Aquarii by two independent groups (e.g. [17, 18, 19]).

### 1.2 AE Aquarii: A Spin-Powered X-Ray Pulsar

It has been suggested [20] that the multi-frequency emission from AE Aquarii is driven by the reservoir of spin-down power as a result of the propeller ejection of material from the system. Comparisons made between the X-ray ( $L_X \sim 10^{30}$  erg s<sup>-1</sup>) and spin-down power ( $P_{\text{s-d}} \sim 10^{34}$  erg s<sup>-1</sup>) in AE Aquarii (e.g. [21, 22, 2]) shows the typical ( $L_X \sim 10^{-3}P_{\text{s-d}}$ ) behaviour inherent to the spin-powered X-ray pulsars, illustrated in Fig.4. This places AE Aquarii in a unique category concerning the cataclysmic variable systems. Utilizing the *Suzaku* satellite, it has been shown that the hard X-ray spectrum ( $E_x \sim 12 - 25$  keV) exhibits a possible power-law contribution with a photon index

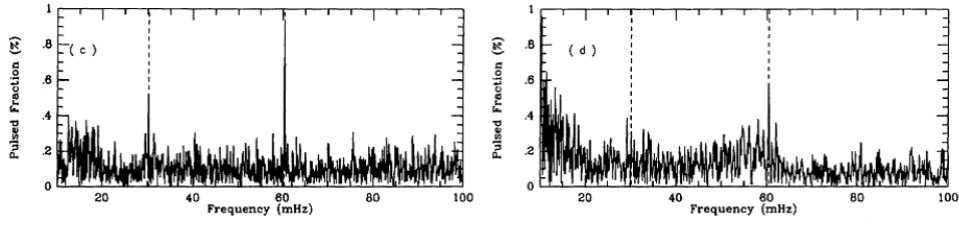

**Figure 1:** Optical FFT of AE Aquarii during quiescence (left) and flares (right) showing the fundamental  $\sim 30$  mHz ( $P_* \sim 33$  s) spin period of the white dwarf and the first harmonic at  $\sim 60$  mHz ( $P_1 \sim 16.5$  s) [second pole]. Note the peculiar low pulsed fraction for a cataclysmic variable system during quiescence and flares, as well as the broad band QPO's that appear in the optical power spectra during flares. Adopted from [19].

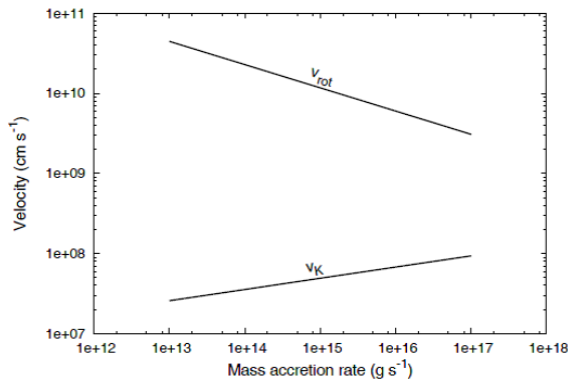

**Figure 2:** Magnetospheric velocity at the magnetospheric radius in comparison with the Keplerian velocity of the flow in AE Aquarii for different mass transfer rates. Adopted from [8].

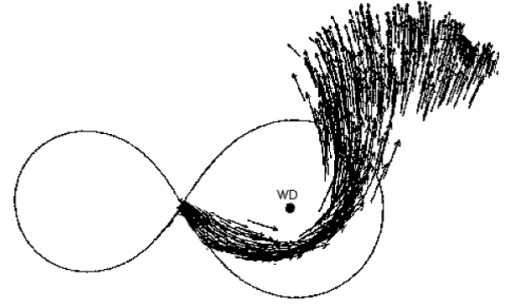

**Figure 3:** Schematic illustration of the magnetospheric propeller driven mass outflow in AE Aquarii. Adopted from [10].

$\alpha \sim 1.12$  [22], which may indicate a non-thermal contribution towards the hard X-ray emission at energies  $E_x \geq 10$  keV (see Fig. 5).

In this general introduction it has been highlighted that AE Aquarii does not conform to the general behaviour of an accretion driven cataclysmic variable system. The fact that the propeller driven spin-down power of the white dwarf dominates the total multi-frequency emission implies that it is most probably the reservoir driving all, or most, of the multi-frequency emission in this system. The paper will be structured as follows: The following session presents a qualitative discussion of the energetics associated with particle acceleration in white dwarf magnetospheres, followed by a discussion of a possible scenario to explain propeller induced non-thermal radio flares involving the magnetospheric field of the secondary star. Then a discussion is presented of the possible pulsar driven weak, but consistent, emission in the *Fermi-LAT* energy window, as well as the reported VHE transient burst-like emission in AE Aquarii. This is followed by a conclusion.

## 2. Particle Acceleration in Rotating Magnetospheres

It can be shown (e.g. [23]) that electric and magnetic fields in a reference frame co-moving

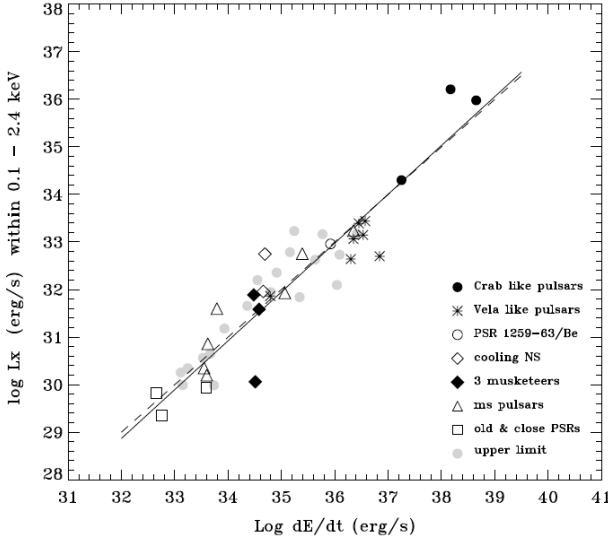

**Figure 4:** X-ray luminosity vs spin-down power of a population of spin-powered pulsars. The diagonal line shows the  $L_x = 10^{-3}P_{s-d}$  relationship which seems to be inherent to spin-powered X-ray pulsars as well as AE Aquarii. Adopted from [21].

with a highly conducting fluid or plasma transform as follows

$$\begin{aligned} \mathbf{E} &= -\gamma(\boldsymbol{\beta} \times \mathbf{B}') \\ \mathbf{B} &= \gamma\mathbf{B}' \end{aligned} \quad (2.1)$$

where  $\boldsymbol{\beta} = \frac{\mathbf{v}}{c}$  and  $\gamma$  the Lorentz factor. The maximum energy that can be attained by a charged particle of charge  $Ze = q$  is

$$\begin{aligned} \epsilon_{\max} &= Ze \int \mathbf{E} \cdot d\mathbf{s} \\ &= q\beta\gamma R_s B' \end{aligned} \quad (2.2)$$

In the fast rotating magnetosphere of a compact object like a neutron star or white dwarf, these parameters are associated with the rotational velocity of the source with respect to a stationary observer. In the equation above  $R_s$  and  $B'$  represent the size of the source and the magnetic field in the frame of the source respectively. This expression clearly illustrates that for fast rotating compact objects, satisfying ( $\beta\gamma \gg 1$ ), the rotational kinetic energy reservoir relaxes the requirements for the strength of the intrinsic magnetic fields in the source to accelerate charged particles to high energies. It can be seen from Figure 6 that even white dwarfs, with magnetic fields ranging between  $\sim 10^5 \text{ G} - 10^8 \text{ G}$ , can theoretically accelerate charged particles to energies of the order of  $\epsilon_{\max} \sim 10^{20} \text{ eV}$  [24].

A similar expression can be derived in the non-relativistic limit ( $\gamma \rightarrow 1$ ), by utilizing the magnetic induction equation [25], which lead to two field components, perpendicular and parallel to

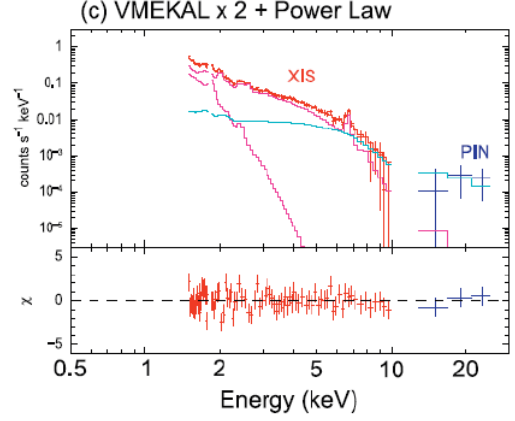

**Figure 5:** X-ray ray spectrum of AE Aquarii (XIS + PIN), showing a possible power-law hard X-ray component in the PIN data which may indicate a non-thermal origin. Adopted from [22].

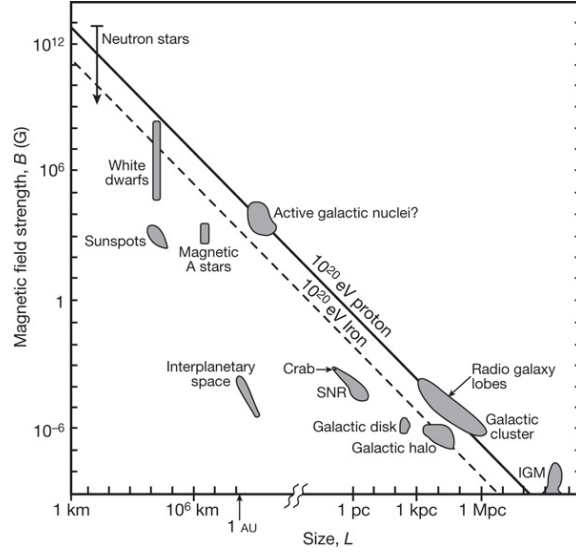

**Figure 6:** The Hillas Diagram. On the horizontal axis there is the typical size of the source and the vertical axis gives the typical source magnetic field. The diagonal lines correspond to the requirements for a  $10^{20}$  eV proton and heavy nucleus respectively. Adopted from [24].

the magnetic fields, i.e.

$$\begin{aligned} \mathbf{E}_\perp &= -\frac{\mathbf{v}}{c} \times \mathbf{B} \left[ 1 + \left( \frac{1}{R_m} \right) \left( \frac{Lv}{c} \right) \left( \frac{\nabla \times \mathbf{B}}{\mathbf{B} \times \mathbf{v}/c} \right) \right] \\ \mathbf{E}_\parallel &= \left( \frac{1}{R_m} \right) \mathbf{E}_\perp. \end{aligned} \quad (2.3)$$

Here,  $R_m$  represents the magnetic Reynolds number, which depends on the conductivity of the plasma, i.e.  $R_m \propto \sigma$  (e.g. [23, 26]). Therefore it can be shown that for a highly conducting ( $\sigma \rightarrow \infty$ ) fluid, the equation for the perpendicular component reduces to the previous equation in the limit  $\gamma \rightarrow 1$ , while the component of the electric field parallel to the magnetic field  $\mathbf{E}_\parallel \rightarrow 0$ . However, one can see that  $\mathbf{E}_\parallel > 0$  for a fluid with low conductivity. This parallel component of the electric field along magnetic flux tubes is the driving force behind the so-called Birkeland-Dessler currents flowing in perturbed magnetospheric circuits (e.g. [25] for a discussion). It can be seen that  $\mathbf{E}_\parallel \rightarrow \infty$  for regions where  $R_m \rightarrow 0$  (i.e.  $\sigma \rightarrow 0$ ), i.e. for anomalously low conductivity. If the electron conduction velocity exceeds the thermal velocity ( $v_{th} = (3kT_e/m_i)^{1/2}$ ) of the particles, microinstabilities can develop (e.g. [25]), leading to anomalously low conductivity. This can be quantified in terms of the following expression [25]

$$\frac{B\sigma}{n_e} \geq 10^2, \quad (2.4)$$

with  $n_e$  the electron density,  $\sigma$  the plasma electrical conductivity and  $B$  the magnetic field. This shows that strong electric fields can be induced in low density plasmas confined by strong magnetic fields.

A consequence of strong field-aligned currents is the acceleration of particles in strong localized potential drops, or double layers (e.g. [27, 20]). These structures can have dimensions of the

order of  $\sim 100 - 1000\lambda_{De}$  (e.g. [28, 29]), with  $\lambda_{De} = 7(T/n_e)^{1/2}$  representing the Debye length of electrons in a plasma. Laboratory experiments seem to indicate that multiple double layers can be induced in a system [29] and that the size of the system essentially determines the length-scale of these structures. In regions of anomalously low conductivity the currents will reach a critical value, i.e.  $j_{||} = en_e f c_s$ , where  $c_s$  represents the speed of sound and where  $n_e$  is the electron density. Here  $f \rightarrow 10$  [27] represents a critical limit for the trigger of microinstabilities that will increase the resistivity of the plasma. The potential drop along the field lines can be determined from energy conservation arguments by comparing the electromagnetic Poynting flux flowing into the double layer with the particle flux out of the double layer [27], i.e.

$$\begin{aligned}\Phi_{||} &= \left( \frac{\text{em flux into double layer}}{\text{particle flux out of double layer}} \right) \\ &= \left( \frac{B^2 v_a}{8\pi en_e f c_s} \right),\end{aligned}\quad (2.5)$$

where  $v_a = B/\sqrt{4\pi\rho_e}$  represents the Alfvén velocity. An interesting consequence of double layer formation in regions where the electron density is extremely low is that the electric field becomes uncontrollably large, resulting in the total power to be released in terms of accelerated particles and possible associated high energy emission. The total power that can be released in accelerated particles is then (e.g. [20])

$$\begin{aligned}P_{dl} &= \int \mathbf{j} \cdot \mathbf{E} dV \\ &= en_e c \Phi_{||} d^2\end{aligned}\quad (2.6)$$

where  $c$  represents the speed of light and  $d$  the width of the double layer.

In the following section it will be shown that the propeller action and associated pulsar-like spin-down in AE Aquarii may in fact be the driving force behind the transient multi-frequency emission in the system, from radio to possibly VHE gamma-rays.

### 3. The Non-Thermal Transient Multi-Frequency Emission in AE Aquarii

The fact that the white dwarf in AE Aquarii behaves like a spin-powered pulsar, combined with the magnetohydrodynamic processes associated with the propeller action, may have interesting consequences regarding particle acceleration and multi-frequency non-thermal emission from radio wavelengths to possibly also VHE gamma-rays, as have been reported contemporaneously by two independent groups [17, 18, 19].

#### 3.1 Propeller Driven Non-Thermal Radio Synchrotron Emission in AE Aquarii

The transient non-thermal radio emission in AE Aquarii [15, 16] have been previously modelled by [12, 13] in terms of expanding synchrotron emitting clouds. Firstly, [12] adopted a scenario where magnetized blobs are imbedded in the mass transfer flow from the secondary star, which are pumped by the fast rotating white dwarf magnetosphere in a *betatron* process, which accelerates electrons to mildly relativistic energies  $\epsilon_e \sim 1$  MeV in magnetic fields of the order of 1000 G (see Fig. 7). An alternative process was considered [13] where Kelvin-Helmholtz instabilities produce

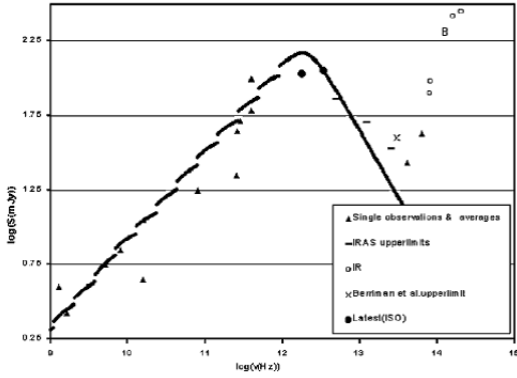

**Figure 7:** Superposition of a few synchrotron emitting flares with high internal magnetic fields of  $B > 1000\text{G}$  and electron energies of the order of  $\epsilon_e \sim 1\text{MeV}$ . Adopted from [12].

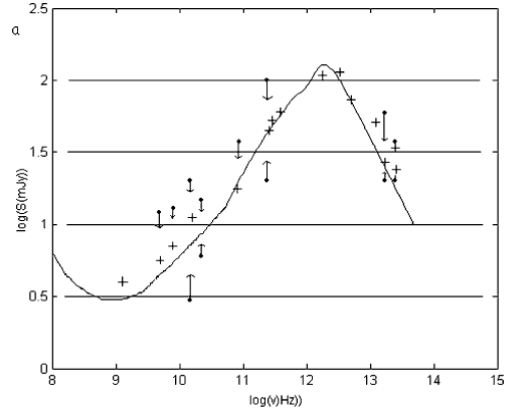

**Figure 8:** The superposition of several blobs with average fields of  $B \sim 400\text{G}$  and average electron energy of the order of  $\epsilon_e \sim 20\text{MeV}$ . Adopted from [13].

magnetized bubbles in the propeller outflow, with reconnecting magnetic fields accelerating the trapped electrons to energies of the order of  $\epsilon_e \sim 20\text{MeV}$  in moderate fields of  $\sim 400\text{G}$  (see Fig. 8).

There is however the possibility that the transient non-thermal radio emission may originate in the magnetospheric field of the secondary star, which is pumped continuously by the white dwarf magnetosphere or the propeller ejected outflow which rams into magnetic prominences extending from the surface of the magnetic secondary star. It has been shown [30] that the secondary stars in cataclysmic variables may have a large scale magnetospheric flux tubes, or prominences, that may extend to the white dwarf star in many cases (see Fig. 9). It has been shown [31] that any disturbance of these magnetospheric flux tubes of the secondary star can account for field aligned potentials and currents, where particles can be accelerated in zones of low conductivity. It can readily be shown that these potentials, for the parameters selected, can reach values of

$$\begin{aligned} \Phi_{\parallel} &= \left( \frac{300(\Delta B_{\perp})^3}{64\pi en^{3/2}\sqrt{4\pi kT}} \right) \text{ Volt} \\ &\geq 10 \left( \frac{\Delta B_{\perp}}{B_0} \right)^3 \left( \frac{n_e}{10^{11}\text{cm}^{-3}} \right)^{-3/2} \left( \frac{T_2}{10^5\text{K}} \right)^{-1/2} \text{ MV}, \end{aligned} \quad (3.1)$$

where  $B_0 \sim 1000\text{G}$  represents the average polar value of the secondary stars's surface field strength. This can easily account for transient synchrotron emission to frequencies of the order of

$$\begin{aligned} v_{\text{syn}} &\approx \frac{\gamma^2 e B}{2\pi m_e c} \\ &\sim \text{few} \times 10^{12} \left( \frac{\gamma}{20} \right)^2 \left( \frac{B}{1000\text{G}} \right) \text{ Hz}, \end{aligned} \quad (3.2)$$

which correlates well with the observed frequency range (see Fig. 7 and Fig 8.) associated with non-thermal transient synchrotron emission in AE Aquarii.

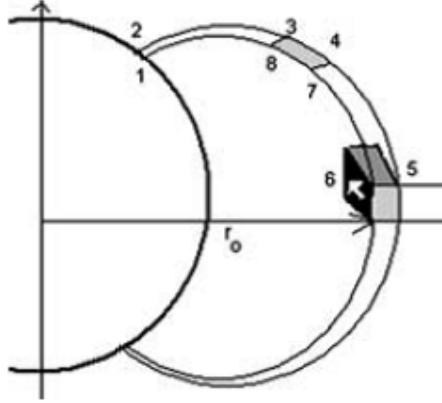

**Figure 9:** The magnetospheric circuit in AE Aquarii. Adopted from [31].

### 3.2 Pulsar-like Particle Acceleration in AE Aquarii: *Suzaku* and *Fermi-LAT*

The presence of a power-law component in the *Suzaku* X-ray spectrum (see Fig. 5) above 10 keV presents an interesting possibility of a pulsar-like particle accelerator in AE Aquarii. The *Suzaku* hard X-ray spectrum seems to suggest a power-law contribution, with a photon index of  $\Gamma \sim 1$  [22], possibly a signature of a non-thermal emission process. The pulsar-like acceleration of particles in the white dwarf magnetosphere in AE Aquarii has been investigated by [22, 3] and [8]. It has been shown that huge potentials of the order of

$$V \sim 3 \times 10^{12} P_{33}^{-2} \mu_{33} \text{ Volt} \quad (3.3)$$

can be induced between the white dwarf surface and the light cylinder, which can accelerate charged particles to VHE-TeV energies. Here  $P_{33}$  and  $\mu_{33}$  represent the white dwarf spin period (33 s) and the magnetic moment of the white dwarf ( $\sim 10^{33} \text{ G cm}^3$ ) respectively. Keeping in mind synchrotron losses, [8, 3] showed that relativistic electrons with Lorentz factors of the order of  $\gamma \sim 10^5$  will radiate synchrotron radiation in the magnetospheric field ( $B_{1c} \sim 100 \text{ G}$ ) in the proximity of the light cylinder at frequencies

$$\nu \sim \text{few} \times 10^{18} B_{100} \gamma_5^2 \text{ Hz}, \quad (3.4)$$

where  $B_{100}$  and  $\gamma_5$  represent the magnetic field ( $\sim 100 \text{ G}$ ) and Lorentz factor ( $\sim 10^5$ ) respectively. It was further shown that the inverse-Compton scattering between  $\gamma \sim 10^5$  electrons and optical photons from the secondary star ( $\epsilon_{\text{ph}} < 5 \text{ eV}$ ), provide interesting possibilities for the production of gamma-rays with energies of the order

$$\epsilon_\gamma \leq 0.2 \gamma_5^2 (\epsilon_{\text{ph}}/5 \text{ eV}) \text{ TeV}, \quad (3.5)$$

which would place it in the *Fermi-LAT* energy range [3, 8, 32]. A *Fermi-LAT* study of pulsed emission in AE Aquarii [33] revealed no steady emission above the noise-level, but some weak consistent pulsed signatures at the first harmonic  $2F_o$  (16.54 s) of the fundamental frequency  $F_o$ .



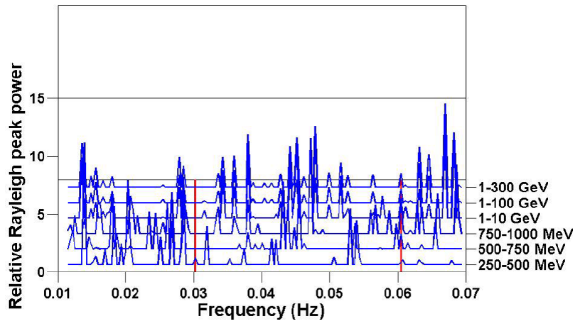

**Figure 10:** A search for pulsed emission of AE Aquarii in various energy bins of the *Fermi-LAT* data. Notice the presence of weak pulsed modulation in all bins simultaneously. Adopted from [33].

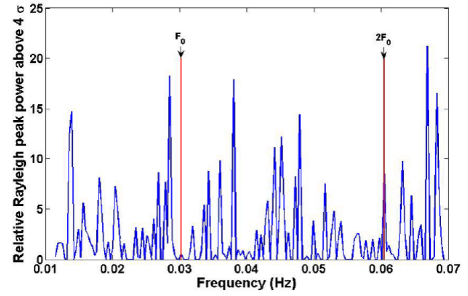

**Figure 11:** Combined power spectrum revealing weak pulsations at  $2F_0$  (16.53 s), which is just the first overtone of the fundamental spin period. Adopted from [33].

(33.08 s). In a search, involving separate energy bins, it has been shown [33] that a consistent modulation at  $2F_0$  ( $= 16.64$  s) is present in all the energy bins (see Fig. 10). The power spectrum involving the combination of the energy bins reveals a consistent pulsation at  $2F_0$ , albeit in the noise level regarding overall significance (e.g. Fig. 11).

### 3.3 Possible VHE Gamma-ray Emission in AE Aquarii

The possibility of AE Aquarii being a VHE gamma-ray source exists since the 1990's as a result of contemporaneous reports by two independent groups (e.g. [17, 18, 19]). The common denominators between the independent reports were that the VHE emission seems to be transient, associated with periods of enhanced optical activity (flares) (see Fig. 12) and in some cases burst-like (see Fig. 13). Similar burst-like emission was reported by the other group observing contemporaneously from Australia [17]. The overall significance of these reports of pulsed emission was at the 99.995% level [18, 19].

The theoretical foundation for this highly transient emission [20] is associated with strong electric potentials developing along the sheared magnetic flux tubes of the white dwarf as a result of the propeller ejection of material. Magnetic shear in the ejection region will induce field-aligned currents in the magnetosphere. Huge potential differences (double layers) can be generated in these circuits where the gas density is low. This will occur close to the white dwarf. In this region potentials of the order of  $\Phi \sim 300$  TV (TV = teravolt) can be generated [19, 20] over very short timescales. As protons and ions are not affected by synchrotron losses, energies in excess of 1 TeV are possible. Very High Energy (VHE) gamma-ray emission can be produced if these proton and ion beams collide with the clumpy gas in, or outside, the ejection zone, producing  $\pi^0$  mesons which will decay almost instantaneously into gamma-rays. VHE gamma-ray emission is possible, if the gas particle density of the target matter is approximately  $N_g \sim 10^{13} \text{ cm}^{-3}$ .

## 4. Conclusions

It has been shown that every form of multi-frequency thermal and non-thermal emission in AE Aquarii from radio to possibly VHE gamma-rays is the direct result of the propeller ejection of

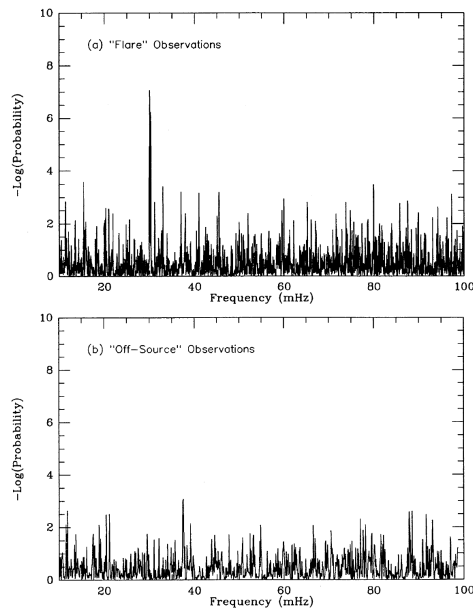

**Figure 12:** Pulsed TeV gamma-ray emission from AE Aquarii at a period close to the spin period of the white dwarf detected during nights where the system show significant flaring activity. The flaring activity was confirmed with simultaneous optical photometry carried out by the author utilizing a 30 inch reflector telescope at the South African Astronomical Observatory (SAAO). Adopted from [19].

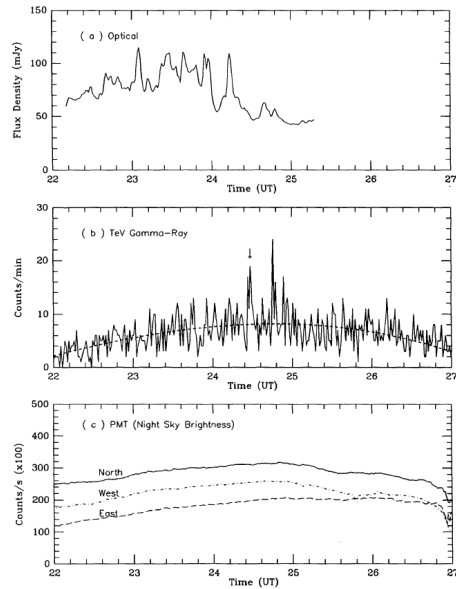

**Figure 13:** Burst-like TeV gamma-ray emission from AE Aquarii during periods of enhanced optical activity. The bottom lightcurves represent the photocurrents of the respective Nooitgedacht Cerenkov units that were operational that night. The stability indicates that the bursts were not induced as a result of instrumental malfunction. Adopted from [19].

matter from the system. It has been shown that the low accretion in this propeller phase may result in pulsar-like potentials to be induced in the white dwarf magnetosphere, which may result in a pulsed signature being visible in *Fermi-LAT* data. A weak, but consistent periodic modulation at the first harmonic of the spin period, namely  $P_1 = 16.54$  s has been detected in the *Fermi-LAT* data, with follow-up analysis underway to substantiate this detection. It has also been pointed out that propeller driven potentials being induced in the secondary star and white dwarf magnetospheres respectively may indeed be the driving mechanisms behind the observed transient multi-frequency emission from radio to possibly VHE gamma-rays. This results in AE Aquarii truly being a unique laboratory for the study of multi-frequency emission through a variety of processes.

### Acknowledgements

The author thank the organisers for the invitation to the conference and their hospitality.

### References

- [1] E. Zinner, *Mitteilungen über veränderliche und verdächtige Sterne*, *Astron. Nach.* **265** (1938) 345

- [2] P.J. Meintjes, A Odendaal & H.J. van Heerden, *AE Aquarii: A short review* in Proceedings of *Golden Age of Cataclysmic Variables and related Objects II* (eds. F. Giovanelli & L. Sabau-Graziati) *Acta Polytechnica CTU proceedings* **2(1)** (2015) 86
- [3] P.J. Meintjes, B Oruru & A. Odendaal, *The multi-frequency properties of AE Aquarii and its evolution from a high mass transfer history*, in Proceedings of *Golden Age of Cataclysmic Variables and related Objects* (eds. F. Giovanelli & L. Sabau-Graziati), *Mem. S.A.It.* **83** (2012) 643
- [4] B. Warner *Cataclysmic variable Stars* (1995) Cambridge University Press, Cambridge 126-215
- [5] J. Patterson, *Rapid oscillations in cataclysmic variables III. An oblique rotator in AE Aquarii*, *ApJ* **234** (1979) 978
- [6] J. Patterson, *The DQ Herculis stars*, *PASP* **106** (1994) 209
- [7] M. Eracleous & K. Horne, *A speedy magnetic propeller in the cataclysmic variable AE Aquarii*, *ApJ* **471** (1996) 427
- [8] B. Oruru & P.J. Meintjes, *X-ray characteristics and the spectral energy distribution of AE Aquarii*, *MNRAS* **421** (2012) 1557
- [9] G.A. Wynn & A.R. King, *Diamagnetic accretion in intermediate polars - I Blob orbits and spin evolution*, *MNRAS* **275** (1995) 9
- [10] G.A. Wynn, A.R. King & K. Horne, *A magnetic propeller in the cataclysmic variable AE Aquarii*, *MNRAS* **286** (1997) 436
- [11] P.J. Meintjes & L.A. Venter, *The diamagnetic blob propeller in AE Aquarii and the non-thermal radio to mid-infrared emission*, *MNRAS* **360** (2005) 573
- [12] P.J. Meintjes & L.A. Venter, *Modelling the continuous radio outbursts in AE Aquarii*, *MNRAS* **341** (2003) 891
- [13] L.A. Venter & P.J. Meintjes, *Kelvin-Helmholtz driven propeller in AE Aquarii: A unified model for the thermal and non-thermal flares*, *MNRAS* **366** (2006) 557
- [14] O.C. de Jager, P.J. Meintjes, D. O'Donoghue & E. Robinson, *The discovery of a brake on the white dwarf in AE Aquarii*, *MNRAS* **267** (1994) 577
- [15] J.A. Bookbinder & D.Q. Lamb, *Discovery of radio emission from AE Aquarii*, *ApJ* **323** (1987) L131
- [16] T.S. Bastian, G.A. Dulk & G. Chanmugam, *Radio Flares from AE Aquarii: A low power analogue to Cyg X-3*, *ApJ* **324** (1988) 431
- [17] C.C.G. Bowden et al., *350 GeV gamma-rays from AE Aquarii*, *Astropart. Phys.* **1** (1992) 47

- [18] P.J. Meintjes et al., *AE Aquarii: An emitter of pulsed TeV gamma-rays resembling optical emission during flares*, *ApJ* **401** (1992) 325
- [19] P.J. Meintjes et al., *Simultaneous optical and TeV gamma-ray observations of the cataclysmic variable AE Aquarii*, *ApJ* **434** (1994) 292
- [20] P.J. Meintjes & O.C. de Jager, *Propeller spin-down and the non-thermal emission from AE Aquarii*, *MNRAS* **311** (2000), 611
- [21] W. Becker & J. Trümper, *The x-ray luminosity of rotation powered neutron stars*, *A&A* **326** (1997) 682
- [22] Y. Terada et al., *Suzaku discovery of hard X-ray pulsations from a rotating magnetized white dwarf, AE Aquarii*, *Publ. Astron. Soc. Japan* **60** (2008) 387
- [23] J.D. Jackson, *Classical Electrodynamics (2nd ed)*, Wiley & Sons, New York, (1975) 473, 552
- [24] P.M. Bauleo & J.R. Martino, *The dawn of the particle astronomy era in ultra-high energy cosmic sources*, *Nature* **458** (2009) 847
- [25] E.N. Parker, *The acceleration of particles to high energy*, in proceedings of *The Physics of Non-Thermal Radio Sources*, G.Setti (ed.), Dordrecht-Reidel Publishing Company, (1976) 137
- [26] C.G. Campbell, *Magnetohydrodynamics in Binary Stars*, Kluwer Academic Publishers (Dordrecht Boston London), (1997) 171-191
- [27] G. Haerendel, *Particle acceleration from field aligned potential droms*, *ApJS* (1994) **90** 765
- [28] M.A. Raadu, *The physics of double layers and their role in astrophysics*, *Phys. Reports* **178** (1989) 25
- [29] M.A. Raadu, *Energy release in double layers*, *Space Science Reviews* **68** (1994) 29
- [30] P.J. Meintjes & E. Jurua, *Secondary star magnetic fields in close binaries*, *MNRAS* **372** (2006) 1279
- [31] L.A. Venter & P.J. Meintjes, *A tenuous X-ray corona enveloping AE Aquarii*, *MNRAS* **378** (2007) 681
- [32] P.J. Meintjes, *The Physics of Transient High-Energy Cosmic Sources: from Radio to VHE Gamma-rays*, in Proceedings of *Multi-Frequency Astrophysics of High Energy Cosmic Sources* (Palermo, 2015), (ed. F. Giovanelli), *Proceedings of Science: PoS(MULTIF15)031*
- [33] H.J. van Heerden, *A search for pulsed high-energy non-thermal emission from the nova-like variable system AE Aquarii*, PhD-Thesis (2015), Univ. of the Free State (unpublished)

## DISCUSSION

**DAVID BUCKLEY:** What analogies can be drawn between AE Aquarii and the so-called "red back" neutron star binaries which transition between propeller and accretor states?

**PIETER MEINTJES:** It is quite possible that AE Aquarii will enter the accretor phase when the white dwarf has spun down sufficiently, perhaps when the rotational period is of the order of a minute or longer, like DQ Hercules. In the propeller phase the spin-down power from the white dwarf in AE Aquarii is believed to be the reservoir that drives the total thermal and non-thermal emission from the system from radio to possible VHE gamma-rays. It is quite possible that these red-back binaries you refer to may also exhibit epochs of non-thermal emission when these systems enter the propeller regime. For AE Aquarii bursts of TeV gamma-ray emission have been reported in the 1990s by two independent groups, where the reported gamma-ray emission amounted to 100% of the spin-down power. It is still a matter of debate what the conversion efficiency of spin down power to non-thermal Very High Energy (VHE) emission in accretion driven systems may be since that will determine how likely a detection of this will be in neutron star binaries. The significant increase in the sensitivity of future telescopes like MeerKAT, SKA and CTA make this a very interesting science case for future studies.

**ELMÉ BREEDT:** Do you detect periodicity in the radio emission of AE Aquarii?

**PIETER MEINTJES:** There have been attempts to search for the 33 s rotation period of the white dwarf in the initial radio studies utilizing the VLA. No periodic signal could be discerned in the radio data in these initial studies since the frequency power spectrum was too noisy. I guess the determining factor will be the sensitivity of the telescope and the integration time. To see the 33 s period I guess the required integration time is significantly less than 33 seconds, perhaps just too short for the sensitivity of the VLA in the 1980s when these studies have been conducted initially. I understand that the system got a significant upgrade since then and it may be a very interesting exercise to repeat this study and search for a non-thermal 33 s signature, which may point to a pulsar-like process acting in the white dwarf magnetosphere. Hard X-ray measurements show a pulsed non-thermal component above 10 keV and the ratio of X-ray luminosity to spin-down power places AE Aquarii in the realm of the spin-powered X-ray pulsars. So with the required sensitivity levels one may definitely investigate this again, given that we are moving into an era where the MeerKAT and SKA telescope systems will provide unprecedented sensitivity in the radio window.