

Implementation of the JEM-EUSO Space Mission Infrared Camera Simulation and Reconstruction Code in the Offline Framework

L. Del Peral^{1, 2}, T. Paul^{1, 3}, J. F. Soriano¹, J. H. Carretero¹, G. Sáez-Cano¹,
M. D. Rodríguez Frías^{*1, 2, 4} for the JEM-EUSO Collaboration

¹ *SPace & AStroparticle (SPAS) Group, UAH, Madrid, Spain.*

² *ISDC, Astronomy Dept. University of Geneva, Switzerland.*

³ *City University of New York, CUNY, New York, USA.*

⁴ *IFIC, CSIC, Dpto. Física Atómica, Molecular y Nuclear, Universitat de València. Spain.*

E-mail: luis.delperal@gmail.com

The JEM-EUSO Atmospheric Monitoring system consists of a bi-spectral Infrared Camera and a LIDAR device that are being fully designed under space qualification to fulfil the scientific requirements of the JEM-EUSO mission. An understanding of the atmospheric conditions in the Field of View of the main telescope is one of the most important tasks for a mission which aims to detect Ultra-High Energy Cosmic Rays (UHECR) and Extremely-High Energy Cosmic Rays (EHECR) from Space using the Earth's atmosphere as calorimeter. In this work the simulation and reconstruction algorithms in the Offline framework are explained. The relevant modules developed for the calibration, simulation, and reconstruction tasks of the images from the infrared camera including its configuration options are discussed and the status of the JEM-EUSO infrared camera modules as implemented in Offline is described.

*The 34th International Cosmic Ray Conference,
30 July- 6 August, 2015
The Hague, The Netherlands*

*Speaker.

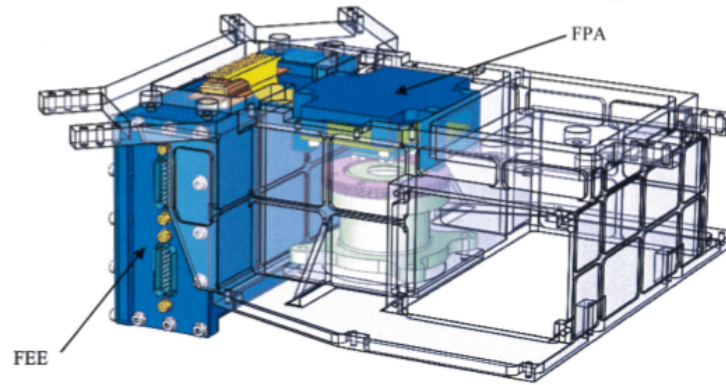

Figure 1: EUSO Infrared Camera design showing the position of the Focal Plane Array (FPA) and the Front End Electronics (FEE).

1. Introduction

The origins and composition of ultra-high energy cosmic rays remains unclear, despite significant experimental and theoretical efforts. The physics potential of this field can be achieved by an upgrade of the performances of ground-based experiments and space-based missions. The Extreme-Universe Space Observatory (EUSO) mission will be located at the International Space Station (ISS) in Nadir observation direction [1, 2, 3]. The EUSO instrumentation will be able to detect Ultra-High Energy Cosmic Rays (UHECR) and Extremely-High Energy Cosmic Rays (EHECR) by using the Earth's atmosphere as a huge calorimeter. Due to the variable nature of the atmosphere an on-time Atmospheric Monitoring (AM) system is one of the most important tasks, and a key element of the space-based mission. Such a dedicated on-site AM system has been designed for the understanding of the atmospheric conditions in the Field of View (FoV) of the main telescope [4, 5, 6, 7]. The EUSO AM system consists of a Long Wave Infrared (LWIR) camera [8, 9] and a LIDAR. The infrared camera will cover the whole FoV of the UV telescope in order to detect the presence of clouds and to determine the cloud coverage and Cloud Top Height (CTH) into the FoV.

2. Infrared Camera description

The IR camera will consists of a Focal Plane Array (FPA) microbolometer detector and a refractive optics system made of Germanium. The FoV of the IR camera is 48° , which covers the whole FoV of the JEM-EUSO telescope. The angular resolution is about 0.1° [10]. A temperature controlled shutter and two blackbodies are used to measure background noise and calibrate on flight the detector system. An accuracy of 3 K in brightness temperature measurement will be achieved in order to determine CTH with an accuracy of 500 m [11]. Two filters split up the FoV in order to overlap images from two sequential frames, providing a bi-spectral IR camera system that allows for stereo vision of the cloud coverage in the FoV (Figure 1).

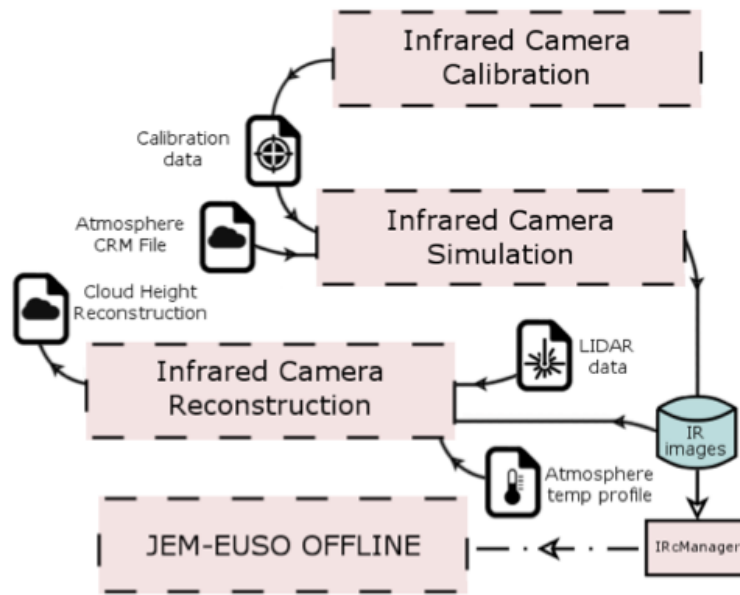

Figure 2: Work flow of the IR *Offline* code.

3. The IR *Offline* code design

The IR Camera code for the JEM-EUSO *Offline* Framework [12, 13] has been divided in three blocks containing calibration, simulation and reconstruction modules. Each block, contains modules that perform specific tasks. Modules run sequentially following the order selected by the user in the `ModuleSequence.xml` configuration file. Figure 2 shows the work flow of the code.

The program starts running with the Infrared Camera Calibration task to obtain the calibration data required by the simulation code. Infrared camera simulation code combines the calibration data with the atmospheric parameters in Atmosphere CRM File to obtain the simulated IR images. These simulated IR images are in the same format as the real data obtained by the IR camera and contain the same information. Both real and simulated images are used by the reconstruction part of the code in order to obtain CTH of the IR images in the FoV. To do this task, the reconstruction code makes use of LIDAR data and atmospheric temperature profiles. An IR camera Manager is in charge of the connection between the IR camera and the rest of the JEM-EUSO *Offline* code.

3.1 Calibration code

The objective of the calibration sequence is to obtain calibration data tables of the infrared camera to be used by the simulation code. The calibration is a process involving 146 iterative steps of the following sequence of modules (Figure 3):

- IRcData – This module reads the infrared camera data parameters, defines spectral bands and defines image variables for each band.
- ImageGenerator – In this module random image is generated to perform a calibration.
- OpticsDiffraction – Calculates diffraction by the point-spread function (PSF) method.

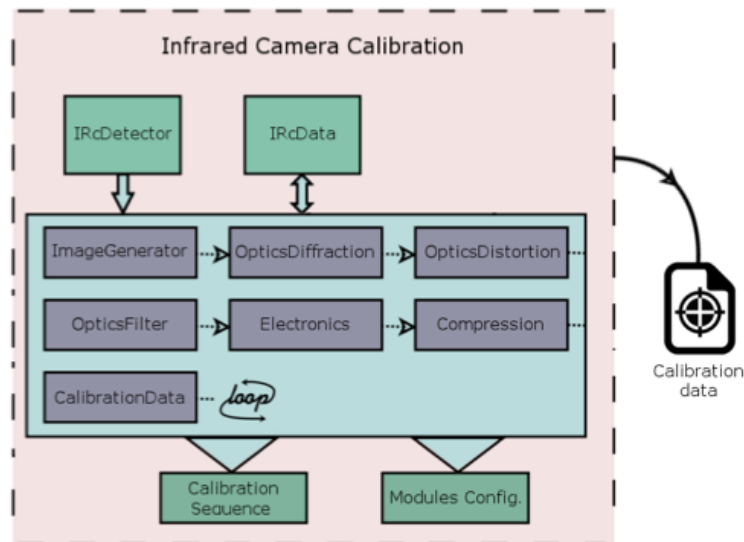

Figure 3: Flow chart of the calibration block of the code.

- OpticsDistortion – Module to applies optical distortion effects to data.
- OpticsFilter – This module apply filter function to data for each band.
- Electronics – Simulates electronics noise and saturation.
- Compression – This module compress and decompress image to evaluate the effects of the compressions algorithm on the data.
- CalibrationData – Process image from calibration simulation and write calibration tables (temperature, counts, error).

Each module has a dedicated XML configuration file in order to define user parameters.

3.2 Simulation modules

The simulation part of the IR camera code has been developed to simulate the performance of the IR camera under different cloudy scenarios. The simulation code use the same modules of calibration, starting with the IRcData module to define the IR camera parameters. Following that, a new module CRMFileReader that reads a user provided file with radiance values from a modeled cloud. With the infrared radiance values, the simulation process starts following the same sequence of the calibration using radiance data. In this way, diffraction, distortion, filter, electronics and compression are simulated by the previously discussed modules in the calibration section. The program flow chart can be observed in Figure 4.

Figure 5 shows a sample of the output of the simulation code of a cloud as seen in the two bands of the IR camera.

An example application, IRcSimulation, has been developed, but visualization tools have still to be prepared.

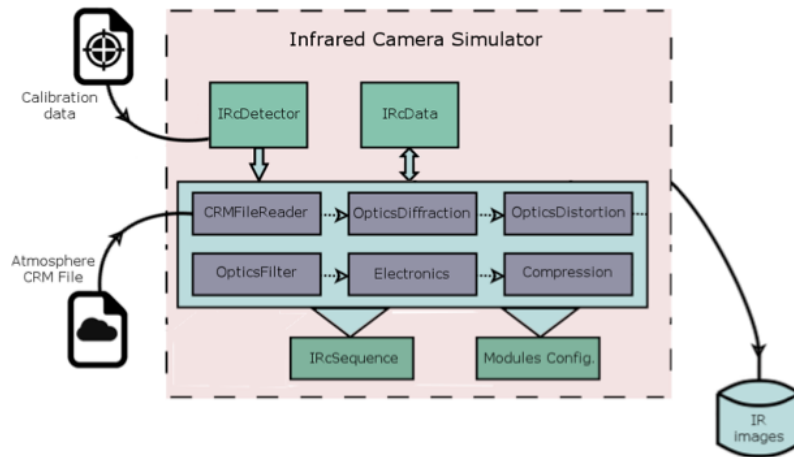

Figure 4: Flow chart of the simulation part of the code.

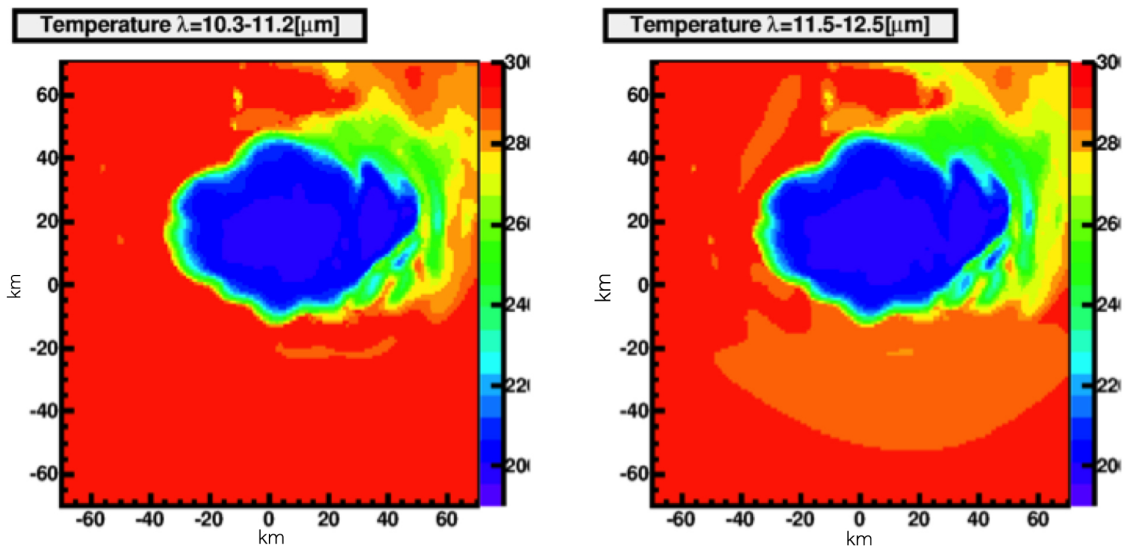

Figure 5: Simulated cloud image for the two bands of the IR camera.

3.3 Reconstruction modules

Figure 6 shows the designed reconstruction modules that are under development. The reconstruction process will use data from the LIDAR, IR images or simulated IR images produced by the simulation part of the code and atmospheric temperature profiles obtained from meteorological satellite data to obtain as final output the CTH needed to analyse experimental data of the main telescope.

The reconstruction has the following module sequence:

- ImageBandJoin – This module overlaps images to obtain biespectral images of the scene.
- LIDARReader – Module to obtain data from the LIDAR.

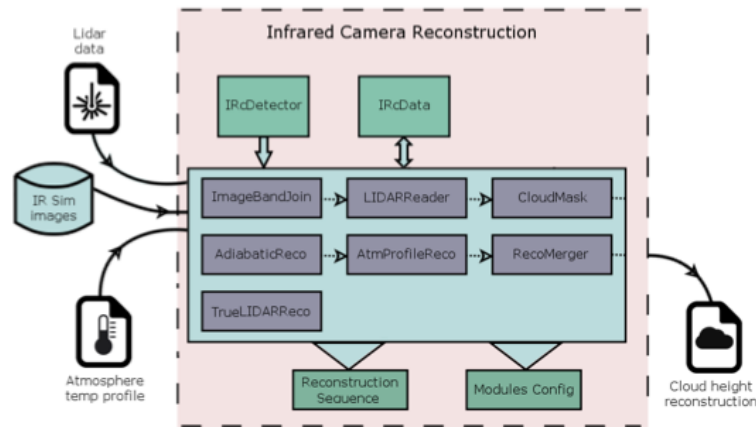

Figure 6: Flow chart of the reconstruction modules.

- **CloudMask** – Computation of a cloud mask, by the use of a ground temperature map, and differences in temperature with the data retrieved by the IR-Camera. The cloud mask is obtained using a ground reference temperature point and its differences in temperature with the data retrieved by the IR-Camera. The reference temperature point is known from LIDAR shot that reach the ground in clear atmosphere. Recognition of cloud areas or clear sky areas is achieved using computer vision software, to recognize shapes, features, and temperature level lines.
- **AdiabaticReco** – Module that makes a first order approximation using an adiabatic method to reconstruct the CTH, by the use of a LIDAR cloud height reference point and computation of the atmosphere adiabatic constant.
- **AtmProfileReco** – The atmospheric profile is taken into account by this module. Reconstruction of the cloud top height is determined from reconstruction the cloud top temperature, and then the atmospheric temperature profile is applied to find the cloud's height.
- **LIDARReco** – LIDAR data are included in the reconstruction in this module. The module simulates the backscattered photons reaching EUSO using the generated 3D optical depth scenery. LIDAR signal inversion is performed using the Klett inversion method [14]. Cloud/Clear atmosphere detection is determined via analysis of the inverted signal optical depth.
- **RecoMerger** – Module that extracts the CTH from all the reconstruction methods.

Figure 7 shows comparison of the CTH results without making use of the LIDAR data (on the left) and with LIDAR data (on the right). The difference is a demonstration of the importance of the presence of a good IR camera and LIDAR combination as a facility for EUSO mission success.

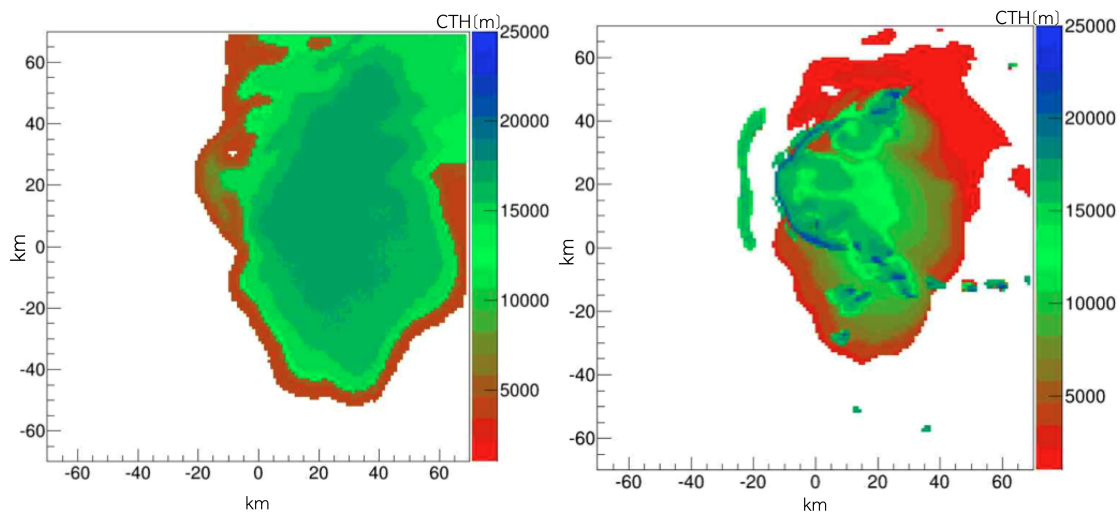

Figure 7: CTHs result from the EUSO IR reconstruction code. On the left, without LIDAR data usage. With LIDAR data on the right.

3.4 Conclusions

A full end to end code to simulate and reconstruct IR camera data for the EUSO project is being implemented in the *Offline* simulation and analysis framework for EUSO. The calibration and Simulation part are implemented but tests and viewer tools must still be developed to complete the functionality of the code and to verify the code. The reconstruction part is now being designed and under development. The code makes use of IR, LIDAR and atmospheric data to obtain the CTH and optical [15] depths as required for the analysis of the main telescope to reconstruct cosmic ray data.

Acknowledgment: This work is supported by the Spanish Government MICINN & MINECO under projects AYA2009-06037-E/AYA, AYA-ESP 2010-19082, AYA2011-29489-C03-01 and AYA2011-29489-C03-02, AYA-ESP2012-39115-C03-01 and AYA-ESP2012-39115-C03-03, AYA-ESP 2013-47816-C4, MINECO/FEDER-UNAH13-4E-2741, CSD2009-00064 (Consolider MULTIDARK) and by Comunidad de Madrid under projects S2009/ESP-1496 & S2013/ICE-2822. The calculations were performed using the Space and Astroparticle SPAS-UAH Cluster. M. D. Rodríguez Frías acknowledges the Swiss National Science Foundation (SNSF) for a Sabbatical research stay at the University of Geneva. L. del Perál acknowledges a senior grant for a Sabbatical stay at University of Geneva from the Spanish Ministerio de Educación, Cultura y Deporte under the “Salvador de Madariaga Programa Estatal de Promoción del Talento y su Empleabilidad en I+D+i, Subprograma Estatal de Movilidad del Plan Estatal de Investigación Científica y Técnica y de Innovación 2013-2016” M D Rodriguez Frias acknowledges a grant under the "Atraccio de Talent" program from the Vicerrectorado de Investigación de la Universidad de Valencia (Spain). This work was partially supported by Basic Science Interdisciplinary Research Projects of RIKEN and JSPS KAKENHI Grant (22340063, 23340081, and 24244042), by the Italian Ministry of Foreign Affairs, General Direction for the Cultural Promotion and Cooperation, by the 'Helmholtz Alliance for Astroparticle Physics HAP' funded by the Initiative and Networking Fund of the Helmholtz Association, Germany, and by Slovak Academy of Sciences MVTS JEM-EUSO as well as VEGA grant agency project 2/0076/13. Russia is supported by the Russian Foundation for Basic Research Grant No 13-02-12175-ofi-m.

References

- [1] Rodríguez Frías, M. D. et al. for the JEM-EUSO Collaboration., The JEM-EUSO Space Mission: Frontier Astroparticle Physics at ZeV range from Space., Homage to the Discovery of Cosmic Rays.

- Nova Science Publishers, New York, ISBN: 978-1-62618-998-0, Inc, pg 201-212, (2013).
- [2] The JEM-EUSO Collaboration, The JEM-EUSO Mission: Contributions to the ICRC 2013, Proc. of 33rd International Cosmic Ray Conference (ICRC), Rio de Janeiro, Brazil. ArXiv:1307.7071, (2013).
- [3] Adams, J.H. et al. (JEM-EUSO Collaboration). An evaluation of the exposure in nadir observation of the JEM-EUSO mission. *Astropart.Phys.*, 44, pg 76-90, <http://dx.doi.org/10.1016/j.astropartphys.2013.01.008>, (2013).
- [4] Rodríguez Frías, M.D., Toscano, S., Bozzo, E., del Peral, L., Neronov, A., and Wada, S. and for the JEM-EUSO Collaboration., The Atmospheric Monitoring System of the JEM-EUSO Space Mission, Proceedings of the 2nd AtmoHEAD Conference, Padova (Italy), ArXiv:1501.0482 [astro-ph.IM] (2014).
- [5] Rodríguez Frías, M. D. et al. for the JEM-EUSO Collaboration., The Atmospheric Monitoring System of the JEM-EUSO Space Mission., Proc. International Symposium on Future Directions in UHECR Physics, The European Physical Journal, 53, 10005-pg1-7, (2013), <http://dx.doi.org/10.1051/epjconf/20135310005>.
- [6] Rodríguez Frías, M. D. et al. for the JEM-EUSO Collaboration., The atmospheric science of JEM-EUSO, In these proceedings.
- [7] The JEM-EUSO Collaboration (corresponding authors: Toscano, S., Morales de los Ríos, J. A., Neronov, A., Rodríguez Frías M. D., & Wada, S.), The Atmospheric Monitoring System of the JEM-EUSO instrument., *Experimental Astronomy*, 37, (2014), doi=10.1007/s10686-014-9378-1.
- [8] The JEM-EUSO Collaboration (corresponding authors Morales de los Rios, J. A. & Rodríguez Frías, M. D.), The infrared camera onboard JEM-EUSO, *Experimental Astronomy*, 37, doi=10.1007/s10686-014-9402-5, (2014).
- [9] Rodríguez Frías, M. D. et al. for the JEM-EUSO Collaboration., Towards the Preliminary Design Review of the Infrared Camera of the JEM-EUSO Space Mission., Proc. International Cosmic Rays Conference, Rio de Janeiro, Brazil, arXiv:1307.7071v1 [astro-ph.IM], (2013).
- [10] Morales de los Ríos, J. A., Joven, E., del Peral, L., Reyes, M., Licandro, J., and Rodríguez Frías, M. D., The Infrared Camera Prototype Characterization for the JEM-EUSO Space Mission., *Nuclear Instruments and Methods NIMA*, 749, 74-83, ISSN 0168-9002 (2014).
- [11] Fernández Soriano et al. for the JEM-EUSO Collaboration. Performances of the Spanish Infrared Camera onboard the EUSO-BALLOON (CNES) flight on August 24, 2014. In these proceedings.
- [12] Argiro, S.; Nellen, L.; Paul, T.C.; Porter, T.; Prado, L, The Offline Software Framework of the Pierre Auger Observatory. Nuclear Science Symposium Conference Record, 2004 IEEE, Issue Date: 16-22 Oct. 2004
- [13] Paul, T. et al. for the JEM-EUSO Collaboration. A new design for simulation and reconstruction software for the JEM-EUSO mission. In these proceedings.
- [14] Klett, J. D., Stable analytical inversion solution for processing lidar returns. *Applied Optics*, 20-2, 211-220 (1981).
- [15] Sáez-Cano, G. et al. for the JEM-EUSO Collaboration. Cloud Optical Depth obtained from the Spanish Infrared Camera data and the Laser shots of the USA helicopter during the EUSO-BALLOON (CNES) flight. In these proceedings.