

## ORKA, The Golden Kaon Experiment: Precision measurement of $K^+ \rightarrow \pi^+ \nu \bar{\nu}$ .

---

**Joseph Comfort, for the ORKA Collaboration**<sup>\*†</sup>

*Arizona State University*

*E-mail:* [joseph.comfort@asu.edu](mailto:joseph.comfort@asu.edu)

Precision measurement of the ultra-rare  $K^+ \rightarrow \pi^+ \nu \bar{\nu}$  decay at Fermilab would be one of the most incisive probes of quark flavor physics this decade. This sensitivity is unique in quark flavor physics and allows probing of essentially all models of new physics that couple to quarks within the reach of the LHC. Furthermore, a high precision measurement is sensitive to many models of new physics with mass scales well beyond the direct reach of the LHC. The ORKA initiative aims to precisely measure this process based on established detector techniques driven with the Fermilab Main Injector high intensity proton source. In recognition of this exciting opportunity the Fermilab director has recently granted scientific approval to the ORKA proposal. The experimental technique and prospects will be discussed.

*The XIth International Conference on Heavy Quarks and Leptons*

*11-15 June, 2012*

*Prague, The Czech Republic*

---

<sup>\*</sup>Speaker.

<sup>†</sup>(ASU, UBC, BNL, FNAL, Illinois, INFN-Napoli, INFN-Pisa, INR-Moscow, JINR, UNBC, UNA Mexico, UA-San Luis Mexico, Texas, Tsinghua).

## 1. Introduction

The recent announcement from CERN about the probable discovery of a Higgs boson is exciting and brings to fruition a major component of the Standard Model (SM). Yet many aspects of particle physics remain uncertain or even unknown. The issues include CP violation and new physics Beyond the Standard Model (BSM), among many others. Is our current knowledge of CP violation in the quark sector sufficient to account the the very large matter-antimatter asymmetry in the universe, or do we need additional sources as, for example, in the lepton sector? Why is the flavor physics that we currently know apparently not affected by the Terascale Physics that we expect? Could that be because there is new physics BSM at a much higher energy scale?

Rare decays have long been a means to search for small and unexpected effects, the rewards sometimes being much larger than the difficulties of the experiments. Their small branching ratios often indicate an underlying cancellation of amplitudes which allows higher-order terms to poke through and be observed. Such rare decays acquire a special role in the LHC era. If new physics is found at the LHC, then precision experiments are essential for sorting out the flavor- and CP-violating couplings of the new particles. If new physics is not found at the LHC, then precision flavor-physics experiments are needed to access the mass scales, through virtual effects, beyond the reach of the LHC. In addition to decays such as  $\mu \rightarrow e\gamma$ ,  $\mu \rightarrow e$  conversion,  $b \rightarrow s\gamma$  and  $B \rightarrow \mu\mu$ , the very rare decays  $K^+ \rightarrow \pi^+ \nu \bar{\nu}$  and  $K_L^0 \rightarrow \pi^0 \nu \bar{\nu}$  take center stage due to their small SM uncertainties and large reach for new physics.

## 2. The $K^+ \rightarrow \pi^+ \nu \bar{\nu}$ Decay.

The ultra-rare  $K^+ \rightarrow \pi^+ \nu \bar{\nu}$  decay mode provides a superb opportunity to test the Standard Model and to search for new physics. The decay rate has been calculated to a high degree of precision within the SM, and advances in accelerator beams along with the technologies of detectors and experiments can provide new crucial tests of the SM.

The one-loop diagrams for the  $s \rightarrow d$  transition are shown in Fig. 1. The contributions from the  $u$  quark can be expressed via CKM unitarity in terms of the  $c$  and  $t$  quarks, and these terms are well understood.

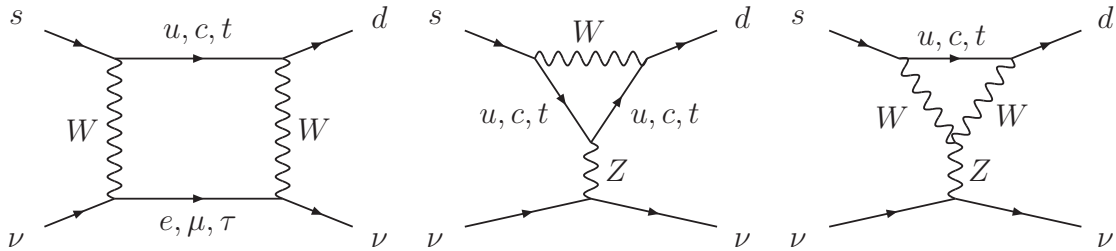

**Figure 1:** One-loop electroweak diagrams for  $K \rightarrow \pi \nu \bar{\nu}$  decays.

The predicted SM branching ratios for the  $K^+ \rightarrow \pi^+ \nu \bar{\nu}$  and the analogue  $K_L^0 \rightarrow \pi^0 \nu \bar{\nu}$  decay modes are [1]

$$\begin{aligned} K^+ &: (7.81_{-0.64}^{+0.72} \pm 0.43) \times 10^{-11}, \\ K_L^0 &: (2.43_{-0.36}^{+0.39} \pm 0.11) \times 10^{-11}, \end{aligned} \quad (2.1)$$

where the first uncertainty in each case stems from the CKM matrix and the second is a combination of other theory uncertainties. The experimental branching ratios for the two modes are

$$\begin{aligned} \text{Expt. } \mathcal{B}(K^+ \rightarrow \pi^+ \nu \bar{\nu}) &= (1.73_{-1.05}^{+1.15}) \times 10^{-10} \quad [2], \\ \text{Expt. } \mathcal{B}(K_L^0 \rightarrow \pi^0 \nu \bar{\nu}) &= 2.6 \times 10^{-8} \quad [3]. \end{aligned} \quad (2.2)$$

The  $K^+$  value is based on seven events in the BNL E787/E949 experiments, while the upper limit for the  $K_L^0$  mode was recently established at the 90% confidence level in the E391a experiment at the KEK 12-GeV Proton Synchrotron in Japan.

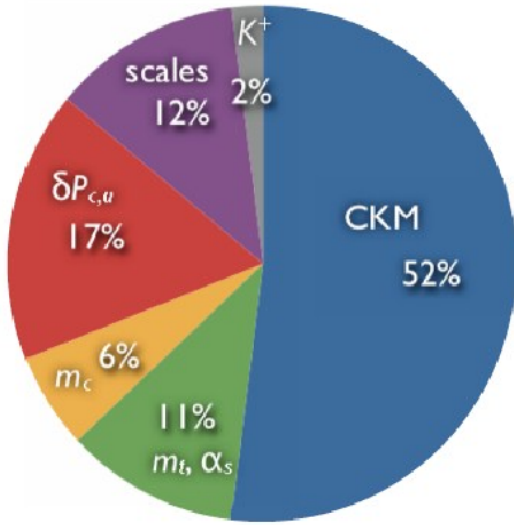

**Figure 2:** Error budget for the  $K^+ \rightarrow \pi^+ \nu \bar{\nu}$  decay in the Standard Model.

Higgs with  $T$  parity (LHT) [5], Randall-Sundrum with custodial protection (RSc) [6], and a 4-generation model (SM4) [7]. The shaded regions along the horizontal axis are excluded at the  $1\sigma$  level by the BNL E787/E949 results [2], while the Grossman-Nir line excludes the  $K_L^0$  decay mode above that line.

### 3. The ORKA Experiment

The ORKA (“Golden Kaon”) experiment for the  $K^+ \rightarrow \pi^+ \nu \bar{\nu}$  decay mode was proposed to Fermilab in November, 2011. It was strongly endorsed by the PAC and given Stage 1 approval by the Director. The intent is to extract a 95-GeV beam from the Main Injector ring onto a production target, select a 600-MeV/c  $K^+$  beam from that target, and bring the particles to rest at the center of a detector assembly. The  $\pi^+$  particles from the decays will be tracked through a magnetic field and identified from their  $\pi^+ \rightarrow \mu^+ \rightarrow e^+$  decay, in the absence of any other activity.

A definitive measurement of the  $K^+ \rightarrow \pi^+ \nu \bar{\nu}$  decay at a  $\sim 10^{-10}$  branching ratio level is a strong experimental challenge. With two undetected decay products, the signal is poorly defined. Potential backgrounds, primarily from other  $K^+$  decays at branching ratios as much as 10 orders of

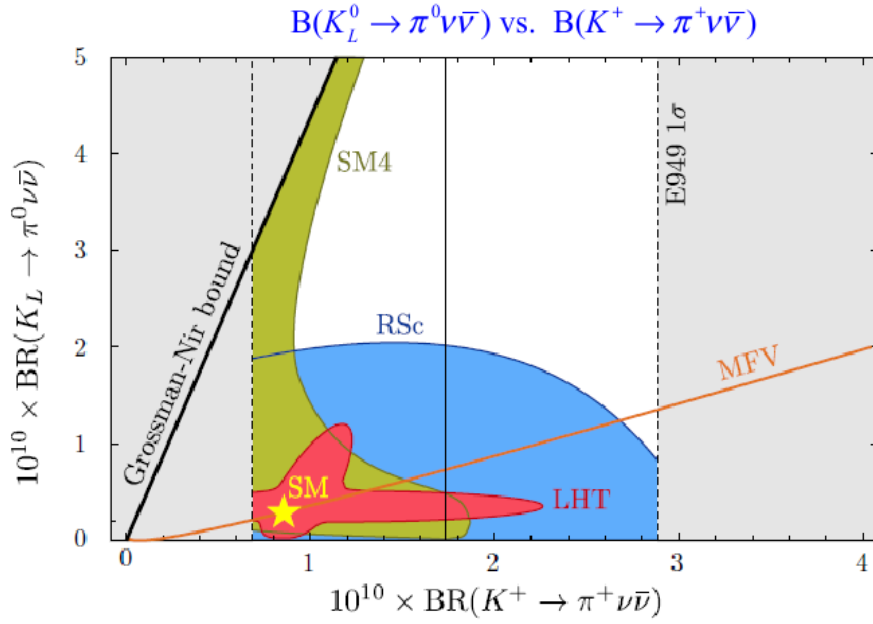

**Figure 3:** Regions of potential new physics. See the text for details.

magnitude larger, have signatures similar to the  $\pi^+$  decay sequence of the events of interest. Hence, backgrounds must be suppressed to exceptionally low levels. To be successful, the detector must have powerful  $\pi^+$  particle identification so that  $K^+ \rightarrow \mu^+ \nu_\mu$  ( $K_{\mu 2}$ ) and  $K^+ \rightarrow \mu^+ \nu_\mu \gamma$  ( $K_{\mu 2 \gamma}$ ) decays can be rejected, highly efficient  $4\pi$  solid-angle photon detection coverage for vetoing  $K^+ \rightarrow \pi^+ \pi^0$  ( $K_{\pi 2}$ ) events and other decays, and an efficient  $K^+$  identification system for eliminating beam-related backgrounds. Blind-analysis methods are essential for analyzing the data.

The ORKA experiment will apply the same design principles as in the earlier BNL E787 and E949 experiments, which provided the first observations of the decay. The BNL experiments were

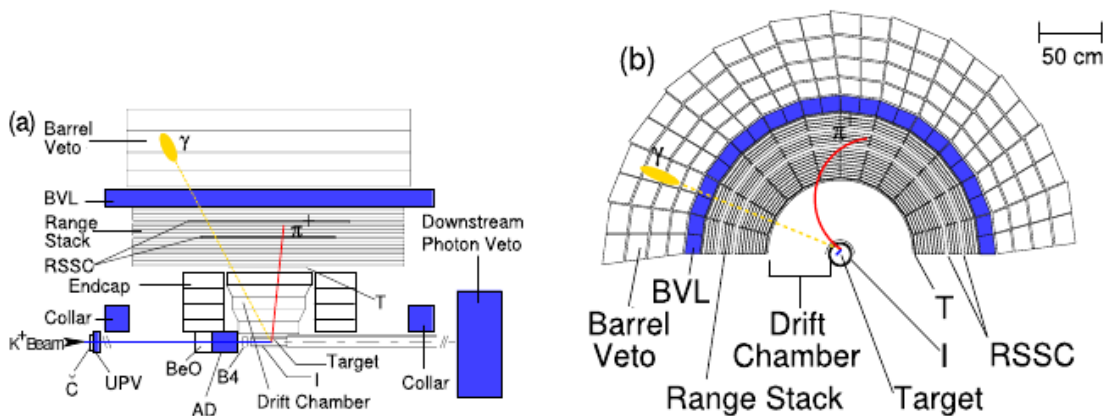

**Figure 4:** Schematic side (a) and end (b) views of the upper half of the E949 detector. An incoming  $K^+$  traverses all the beam instruments, stops, and decays. The outgoing  $\pi^+$  and one photon from  $\pi^0 \rightarrow \gamma \gamma$  are also shown.

the culmination of a long series of similar experiments spanning 40 years. Like their predecessors, E787/E949 employed a low-momentum beam of stopping kaons. In E949, a pure  $K^+$  beam at 710-MeV/c was slowed in a degrader and stopped in a highly segmented scintillating fiber target detector. The target was surrounded with tracking drift chambers, a range stack, and photon veto detectors. The scheme is illustrated in Fig. 4.

Two important kinematics regions can be used for analyzing the data, denoted as PNN1 and PNN2 in Fig. 5. The PNN1 region lies between the  $K^+ \rightarrow \pi^+ \pi^0$  ( $K_{\pi 2}$ ) momentum (21% branching ratio) and the  $\pi^+$  kinematic limit of 227 MeV/c. The  $K^+ \rightarrow \mu^+ \nu_\mu$  ( $K_{\mu 2}$  decay (64% branching ratio) occurs above that value. The PNN2 region lies below the  $K_{\pi 2}$  decay momentum but above the  $3\pi$  regions. It is more complicated by having some  $K_{\ell 3}$  decay modes. The regions are illustrated in Fig. 5.

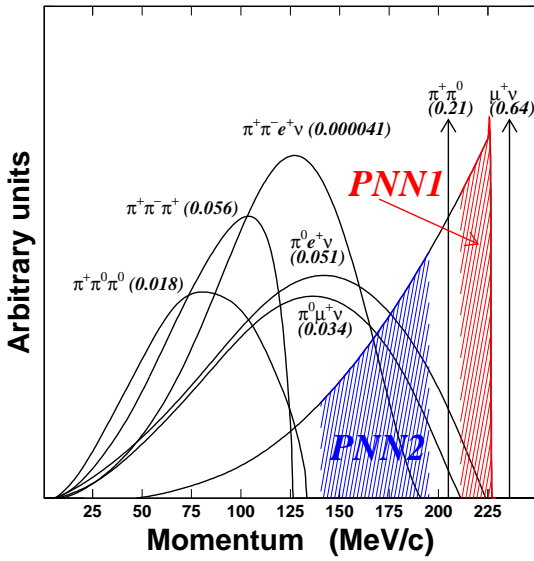

**Figure 5:**  $\pi^+$  (or  $\mu^+$ ) momentum distributions for several  $K^+$  decay modes. The respective branching ratios are shown in parentheses.

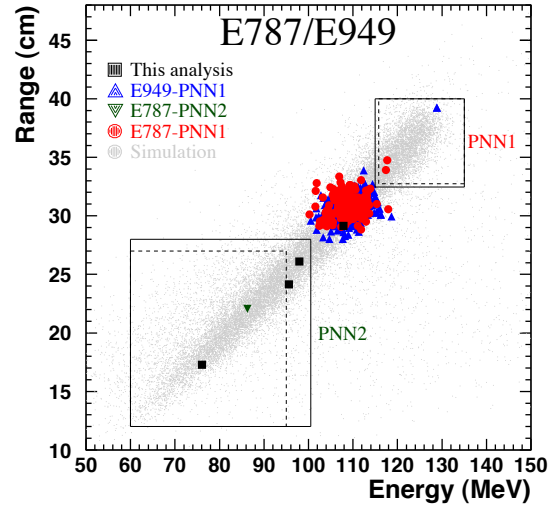

**Figure 6:** Range vs.  $\pi^+$  kinetic energy for observed events in the two kinematic regions. The E787 and E949 signal regions are denoted by dashed and solid lines, respectively.

Data from the E787 and E949 experiments are shown in Fig. 6, with the two signal regions shown as boxes. Three events were observed in the PNN1 region, and an additional four events were observed in the PNN2 region. To provide an effective test of the SM and to search for new physics, the yields need to be increased by two orders of magnitude or more.

#### 4. Implementation

As mentioned above, a 95-GeV beam will be extracted from the Fermilab Main Injector ring and directed to a production target. There are several possibilities for the location of the target and detector. The most favored option is the CDF Hall, along with the CDF magnet. A beam transport line will need to be constructed, and the existing detectors removed from the magnet. A low-momentum beam line, with a  $90^\circ$  bend, was used to select a  $K^+$  beam from the production

target in the E949 experiment. A shorter beam line is needed for ORKA. To accommodate the CDF magnet as much as possible, a  $K^+$  beam line with a dogleg needs to be designed. The magnet then only needs to be shifted slightly sideways from the Tevatron line.

Although the detector assembly will have the same overall structure as those for E787/E949, the components will be entirely redesigned and rebuilt. A sketch of the general design is given in Fig. 7. Critical goals include a substantially higher  $K^+$  stopping rate, with little increase in accidental rates, a factor of 10 improvement in acceptance, finer segmentation, improved resolutions, and reduced backgrounds.

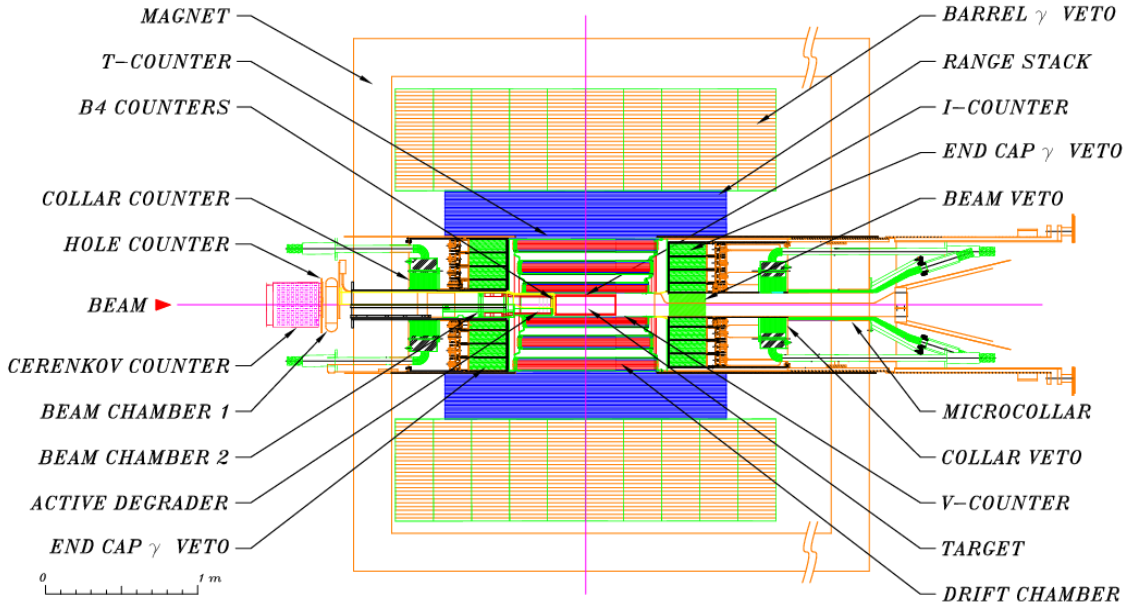

**Figure 7:** Elevation view of the proposed ORKA detector. The beam enters from the left, and several key components are labeled.

A 600-MeV/c  $K^+$  beam was chosen to maximize the flux as well the ability to stop the kaons without generating excessive backgrounds. The beam will be degraded and stopped in a highly segmented active scintillating target. The target region will be surrounded by a central drift chamber and segmented scintillation detectors for measuring the pion range, energy, and the  $\pi - \mu - e$  decay sequence. Beyond these components will be an efficient  $4\pi$  solid-angle calorimeter for vetoing events accompanied by gamma rays. The CDF solenoid magnet (or equivalent), will be used with a 1.25-T magnetic field to allow a longer detector with increased solid-angle acceptance and improved momentum resolution. Other improvements over the BNL experiments are anticipated, including  $4\times$  finer segmentation of the pion stopping-region ‘Range Stack’ (RS) detectors. The photon veto detector will also be enhanced by using 23 radiation lengths compared to 17.3 in E949. The length of the Drift Chamber, Range Stack, and Barrel Veto can be extended from 50 cm to 80 cm in the beam direction to increase the solid-angle acceptance of the detector.

A general comparison of the E949 and proposed ORKA experiments is shown in Table 1. Much of the improvements here come from a higher stopping fraction and higher stopping rate of the  $K^+$  beam. An event acceptance increase of more than a factor of 10 is estimated from

improvements in the detector design, as listed in Table 2. The large improvement in identifying the decay chain comes from better identification of where the  $\pi^+$  stops in the range stack, and an improved ability to detect the  $\pi \rightarrow \mu$  and  $\mu \rightarrow e$  decays in the stopping counter and neighboring counters. In Table 2, macro-efficiency refers typically higher beam-on times at Fermilab than for the E949 experiment. A 2-ns delayed coincidence between the stopped kaon and the outgoing pion in the E949 experiment, and it is believed that it can be removed with improvements in the trigger and DAQ system.

Item	E949	ORKA
Proton beam momentum (GeV/c)	21.5	95
Duty factor (%)	41	44
$K^+$ momentum (MeV/c)	710	600
$K^+$ fraction stopping in target (%)	21	54
Ave. rate of stopped $K^+$ /s ( $\times 10^6$ )	0.7	4.8
Accidental loss (%)	23	28
<b>Events/year (SM)</b>	1.3	210

**Table 1:** Comparison of E949 and ORKA experiments

Component	Acceptance factor
$\pi \rightarrow \mu \rightarrow e$	$2.24 \pm 0.07$
Deadtimeless DAQ	1.35
Larger solid angle	1.38
1.25-T magnetic field	$1.12 \pm 0.05$
Range stack segmentation	$1.12 \pm 0.06$
Photon veto	$1.65^{+0.39}_{-0.18}$
Improved target	$1.06 \pm 0.06$
Macro-efficiency	$1.11 \pm 0.07$
Delayed coincidence	$1.11 \pm 0.05$
Product	$11.28^{+3.25}_{-2.22}$

**Table 2:** Incremental increases in signal acceptance of ORKA compared to E949.

When all of the improvements are considered, and based on the considerable experience from the BNL experiments, the number of events for ORKA is expected to be about 210/year — two orders of magnitude greater than achieved at BNL. Including background uncertainties, the experimental precision will approach that of the Standard Model after about 3 years, and exceed it after 5 years as shown in Fig. 8.

## 5. Current Activities

Because there is high community interest in pursuing a precision measurement of the  $K^+ \rightarrow \pi^+ \nu \bar{\nu}$  decay, and with the strong support of the Fermilab PAC, strong efforts are being made to

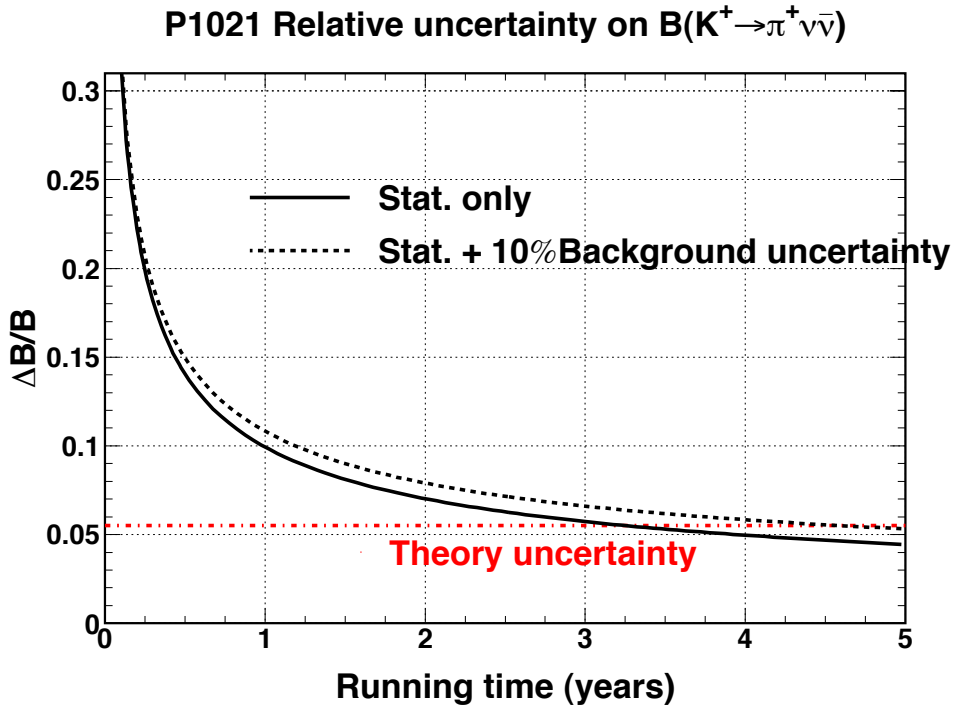

**Figure 8:** The fractional uncertainty in the  $K^+ \rightarrow \pi^+ \nu \bar{\nu}$  branching ratio as a function of running time. The theory uncertainty (red) does not include uncertainties in the CKM matrix elements.

mount the ORKA experiment as soon as possible. Fermilab has already given Stage 1 approval in Decemeber 2011.

With this approval, strong planning and design efforts are being made on tasks needed to implement the CDF option. In June, the Fermilab directorate committed resources to kickoff preservation of the CDF hall and infrastructure for eventual potential use by the ORKA experiment. Planning work is underway for a beam line in the Tevatron tunnel from the Main Injector extraction point to the CDF hall, and to identify the beam-line elements needed for it. Good progress is being made on a dog-leg design for the  $K^+$  beam line between the production target and the ORKA detector. Research and development work is being pursued on the detector and data acquisition systems.

As presented elsewhere in this conference, the CERN NA62 experiment is also preparing for a measurement of the  $K^+ \rightarrow \pi^+ \nu \bar{\nu}$  decay. It is utilizing an entirely different method of in-flight decays with an unseparated 75-GeV/c hadron beam. Research and development is near completion and detector construction is well along. The anticipated running schedule is discussed elsewhere in these proceedings, with a goal of obtaining 100 or more events.

If new physics is seen in NA62, confirmation by ORKA with a much larger yield will be necessary. The very different methods in the two experiments is a distinct advantage in this case. On the other hand, if new physics is not identified in NA62, ORKA can continue to push the precision of the  $K^+ \rightarrow \pi^+ \nu \bar{\nu}$  decay rate for comparison with the SM predictions and to search towards a much higher level of sensitivity.



## 6. Other Opportunities

In addition to the primary focus on the  $K^+ \rightarrow \pi^+ \nu \bar{\nu}$  decay, several other opportunities for new physics will be available. A few of them are noted very briefly here. An extended list with more details is available elsewhere [8].

### $K^+ \rightarrow \pi^+ X^0$

Many BSM theories include a new light or massless particle  $X^0$  such as a familon, or various species of axions, light scalar pseudo-Nambu Goldstone bosons, sgoldstinos, dark matter candidates, and others. Identification in a two-body decay is easily made by looking for missing energy where the  $\pi^+$  is detected with a resolution comparable to that provided by the apparatus.

### $K^+ \rightarrow \pi^+ \pi^0 \nu \bar{\nu}$ and $K^+ \rightarrow \pi^+ \pi^0 X^0$

Based on well-measured  $K_{e4}$  branching ratios, the Standard Model can make a good prediction of the first of these two modes. So an additional high quality test of the SM can be made, with enhanced sensitivity to terms that might indicate new physics. For the latter mode, reduced upper limits can be placed on the  $m_X$  spectrum.

### $K^+ \rightarrow \pi^+ \gamma$

This mode violates angular momentum conservation and gauge invariance, but is allowed in non-commutative theories or those with other departures from point-particle quantum field theory and/or Lorentz invariance.

## 7. Summary

The ORKA measurement of the  $K^+ \rightarrow \pi^+ \nu \bar{\nu}$  decay rate provides a unique opportunity to search for new physics in rare kaon decays by using the existing Fermilab facilities. With a high-intensity beam from the Main Injector, the decay rate can be measured to 5% or better, comparable to the uncertainties in the Standard Model. Deviations by only  $\sim 30\%$  from the SM predictions can point to new physics at the  $5\sigma$  level. By working earnestly, data acquisition can begin by 2017, with the first results available by 2020.

The ORKA experiment complements the abundant studies that are being done and will be done at the LHC, as described in the the proceedings of this conference. Whether or not new physics is discovered at the LHC, very high precision of  $K \rightarrow \pi \nu \bar{\nu}$  decays are needed to fully understand the mechanisms of CP violation and flavor couplings.

In the longer run, ORKA will provide a major step towards the Fermilab Intensity Frontier program, which will have a high impact across a broad spectrum of particle physics and cosmology. It will also provide a high quality training opportunity for the future generation of scientists.

## References

- [1] J. Brod, M. Gorbahn, and E. Stamou, Phys. Rev. D **83**, 034030 (2011).
- [2] A. V. Artamonov *et al.*, Phys. Rev. D **79**, 092004 (2009), and references therein.
- [3] J. K. Ahn *et al.*, Phys. Rev. **81**, 072004 (2010).

- [4] D. M. Straub in Proceedings of CKM2010, University of Warwick, UK, arXiv:1012.3893.
- [5] M. Blanke *et al.*, Acta Phys. Polon. B **41**, 637 (2010) [arXiv:0906.5454].
- [6] M. Blanke *et al.*, JHEP **0903**, 108 (2009) [arXiv:0812.3803].
- [7] A. J. Buras *et al.*, JHEP **1009**, 106 (2010) [arXiv:1002.2126].
- [8] L. Littenberg, private communication (2012).